

UCFK 205 ASAHI

Ball bearing units

TYPE: Housing units, Three-bolt flange bracket units, Cast iron housing, Radial insert ball bearing with grub screws in inner ring, Type UCFK (ASAHI)

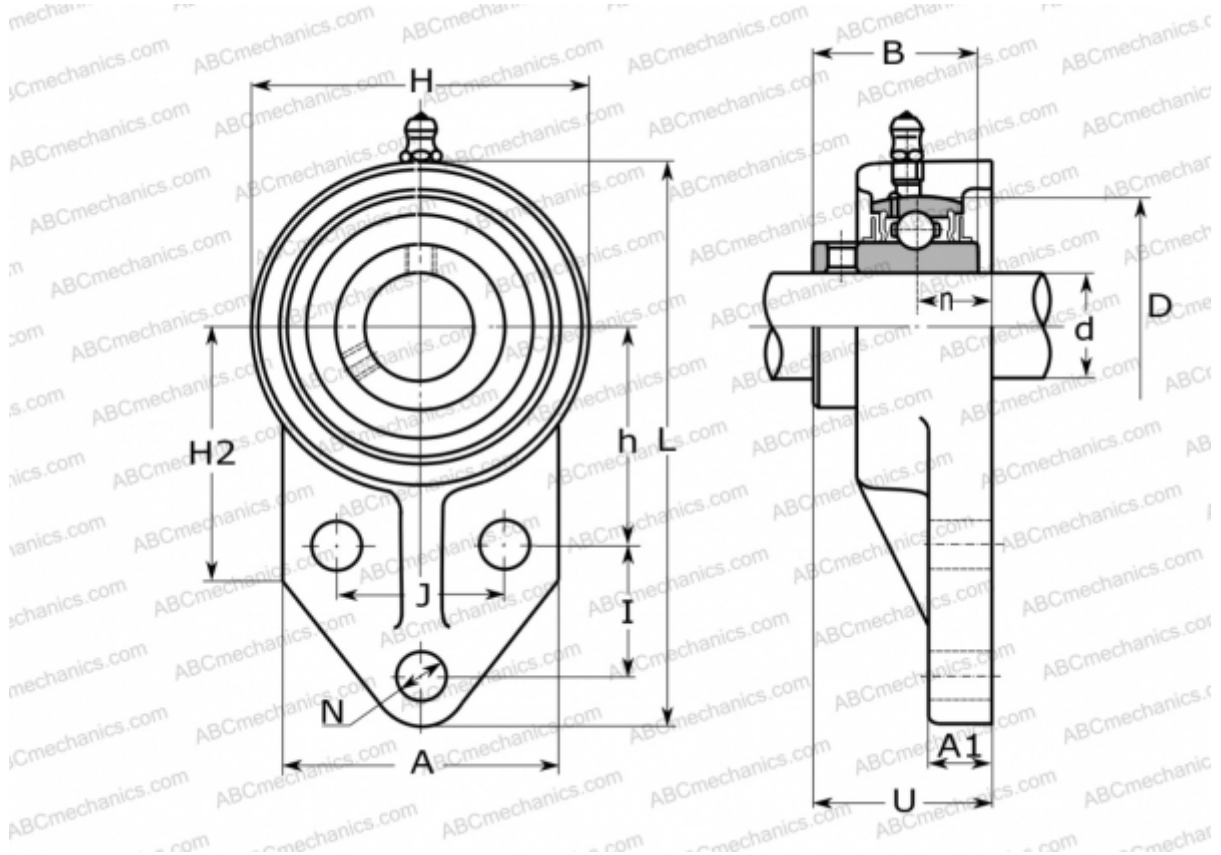

Technical specification

DIMENSIONS, MM

d	25,000
D	52,000
B	34,100
L	116,000
H	68,000
A	56,000
H2	52,000
J	34,000
A1	13,000
N	10,000
U	35,700
I	27,000
h	45,000
n	16,000

WEIGHT, KG

	0,660
Bearing	UC 205
Housing	FK 205

MANUFACTURER

[ASAHI](#)