

UCFK 207 ASAHI

Ball bearing units

TYPE: Housing units, Three-bolt flange bracket units, Cast iron housing, Radial insert ball bearing with grub screws in inner ring, Type UCFK (ASAHI)

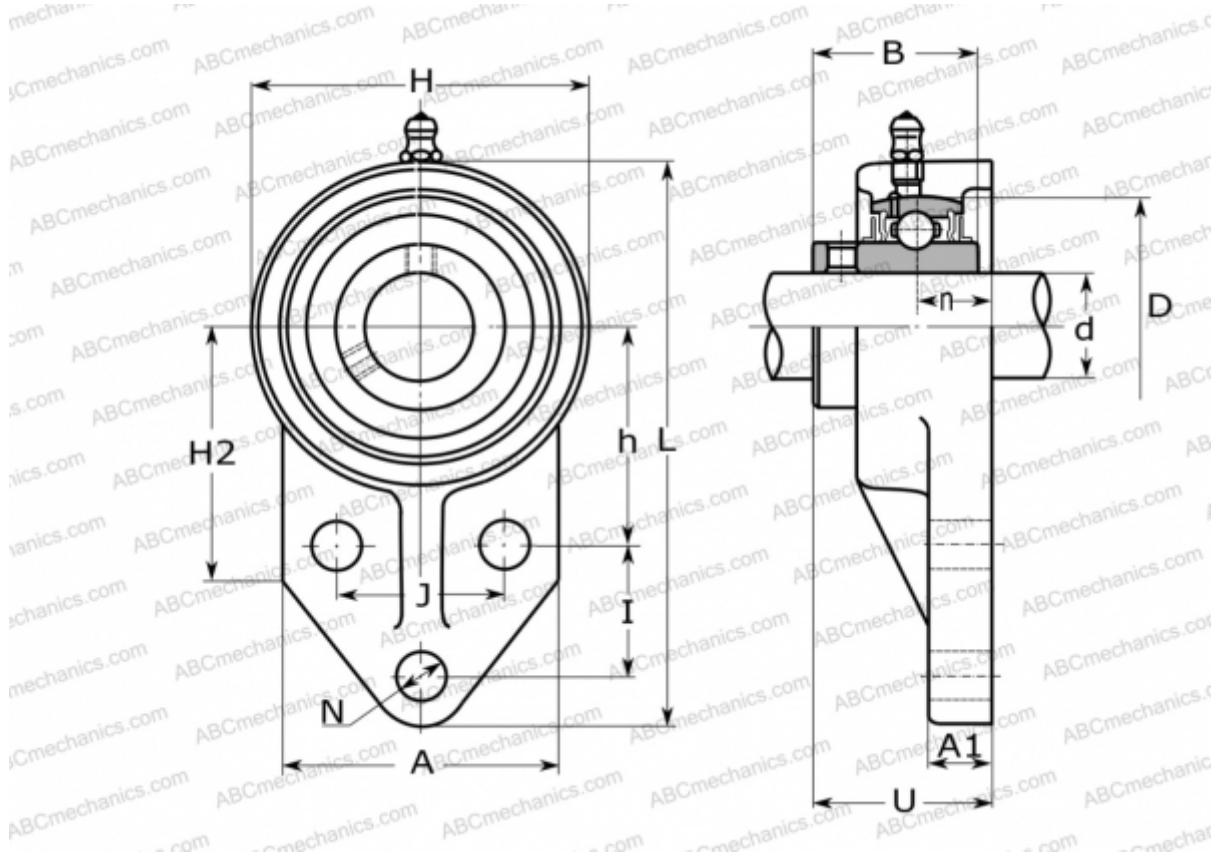

Technical specification

DIMENSIONS, MM

d	35,000
D	72,000
B	42,900
L	144,000
H	90,000
A	70,000
H2	62,000
J	46,000
A1	15,000
N	10,000
U	44,400
I	32,000
h	55,000
n	19,000

WEIGHT, KG

	1,300
Bearing	UC 207
Housing	FK 207

MANUFACTURER

[ASAHI](#)