

UCFK 210 ASAHI

Ball bearing units

TYPE: Housing units, Three-bolt flange bracket units, Cast iron housing, Radial insert ball bearing with grub screws in inner ring, Type UCFK (ASAHI)

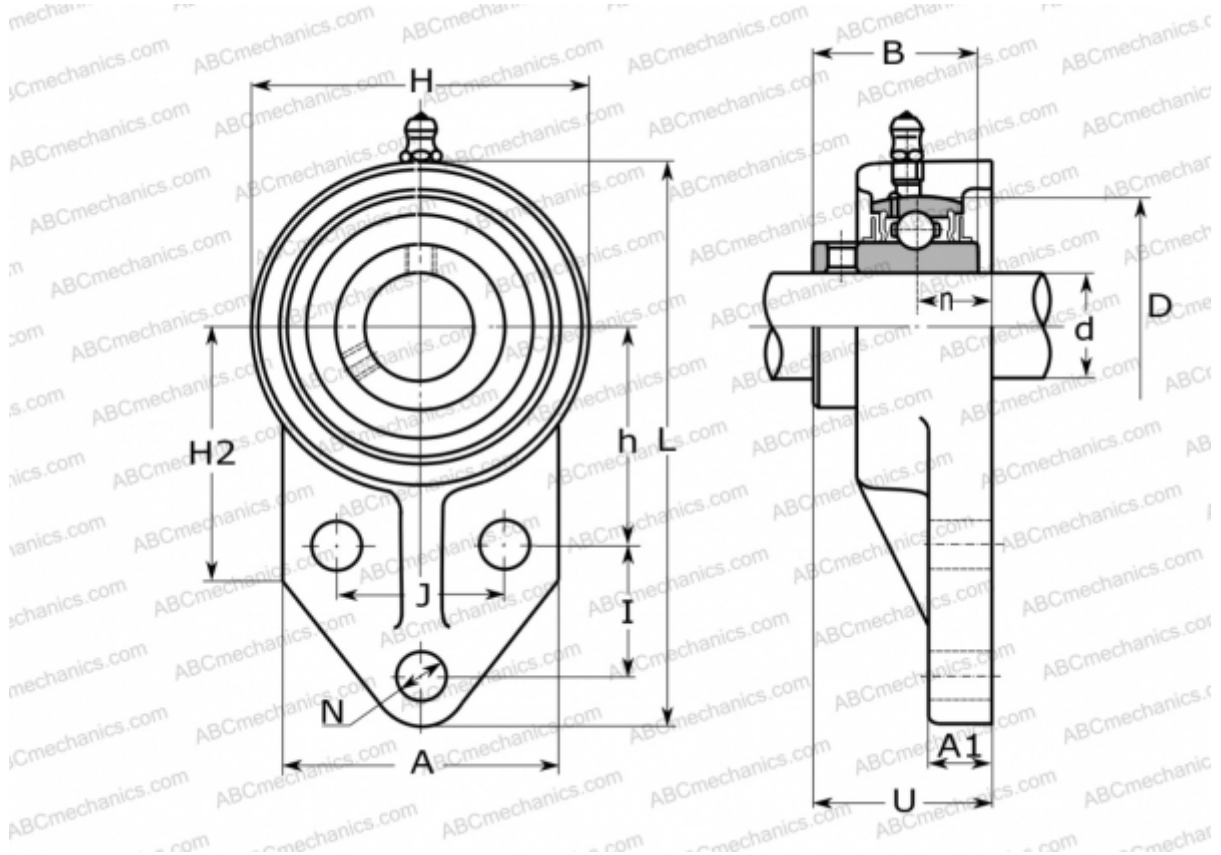

Technical specification

DIMENSIONS, MM

d	50,000
D	90,000
B	51,600
L	184,000
H	112,000
A	86,000
H2	82,000
J	58,000
A1	18,000
N	12,000
U	54,600
I	46,000
h	68,000
n	22,000

WEIGHT, KG

	2,200
Bearing	UC 210
Housing	FK 210

MANUFACTURER

[ASAHI](#)