

PFT 20 TF SKF

Ball bearing units

TYPE: Housing units, Two-bolt flanged housing units, Sheet steel housing, Radial insert ball bearing with grub screws in inner ring, Type PFT..TF (SKF)

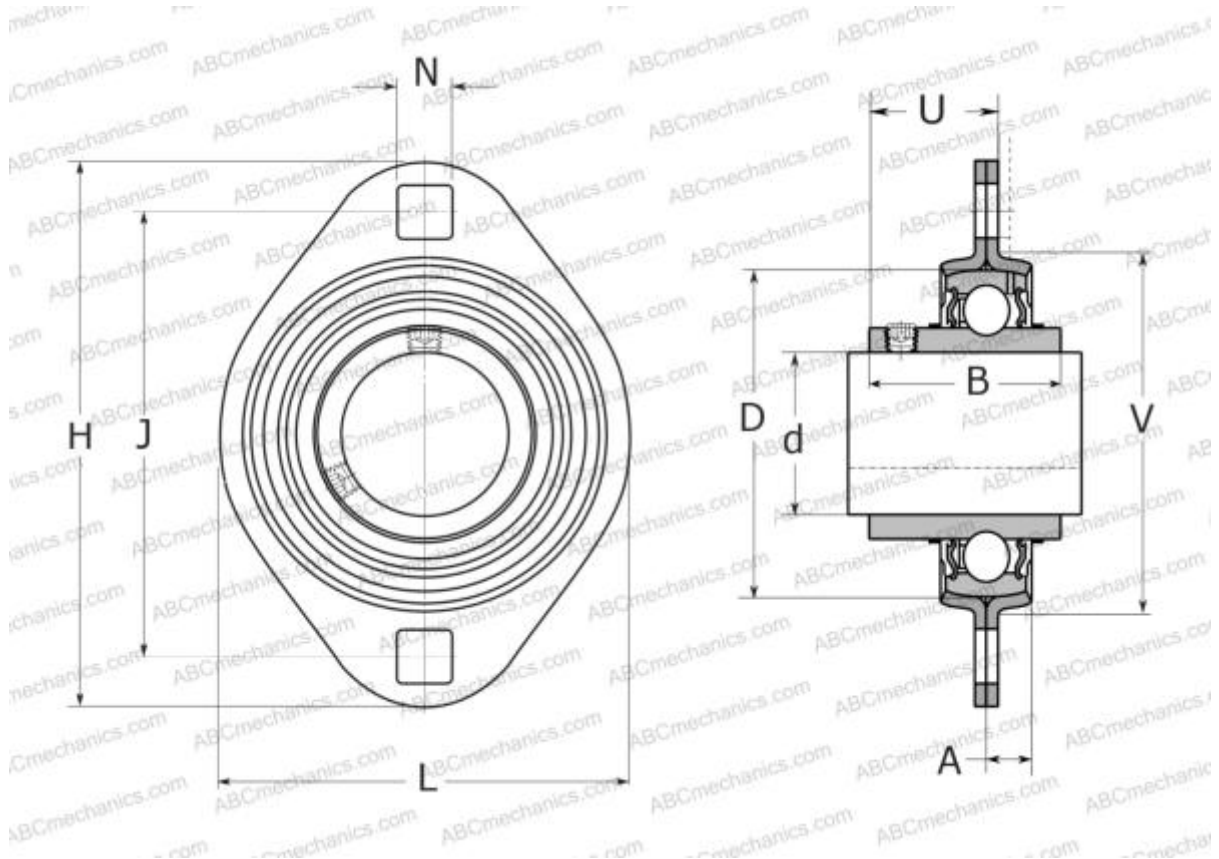

Technical specification

DIMENSIONS, MM

d	20,000
D	47,000
B	31,000
H	91,000
A	8,000
J	71,500
H1	67,000
N	8,700
U	20,300
V	55,000

WEIGHT, KG 0,230

Bearing	YAR 204-2F
Housing	PFT 47

MANUFACTURER

[SKF](#)

CALCULATION DATA

Basic dynamic load rating, C	12,700 kN
Basic static load rating, Co	6,550 kN
Fatigue load limit, Pu	0,280 kN