

PFT 30 TF SKF

Ball bearing units

TYPE: Housing units, Two-bolt flanged housing units, Sheet steel housing, Radial insert ball bearing with grub screws in inner ring, Type PFT..TF (SKF)

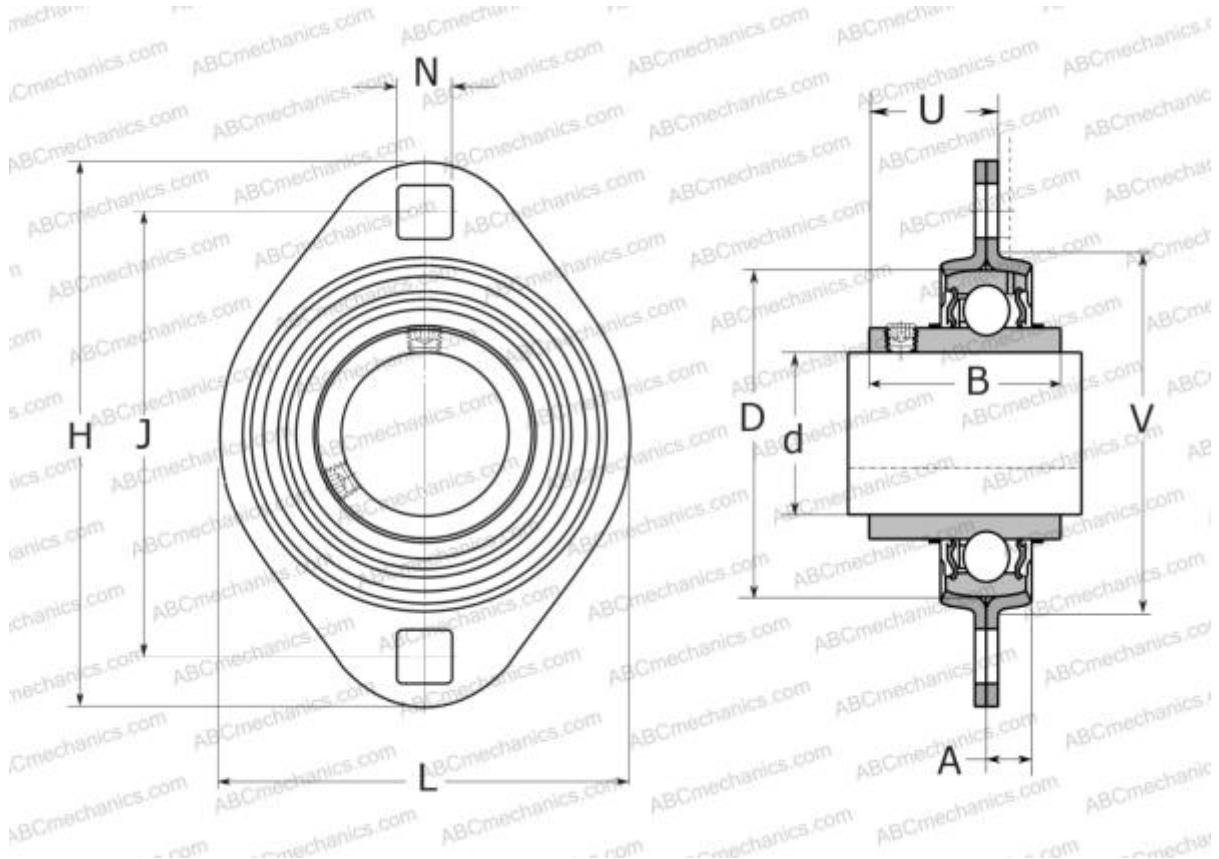

Technical specification

DIMENSIONS, MM

d	30,000
D	62,000
B	38,100
H	112,000
A	9,500
J	90,500
H1	84,000
N	10,500
U	24,700
V	71,000

WEIGHT, KG 0,460

Bearing	YAR 206-2F
Housing	PFT 62

MANUFACTURER

[SKF](#)

CALCULATION DATA

Basic dynamic load rating, C	19,500 kN
Basic static load rating, Co	11,200 kN
Fatigue load limit, Pu	0,475 kN