

PFT 35 TF SKF

Ball bearing units

TYPE: Housing units, Two-bolt flanged housing units, Sheet steel housing, Radial insert ball bearing with grub screws in inner ring, Type PFT..TF (SKF)

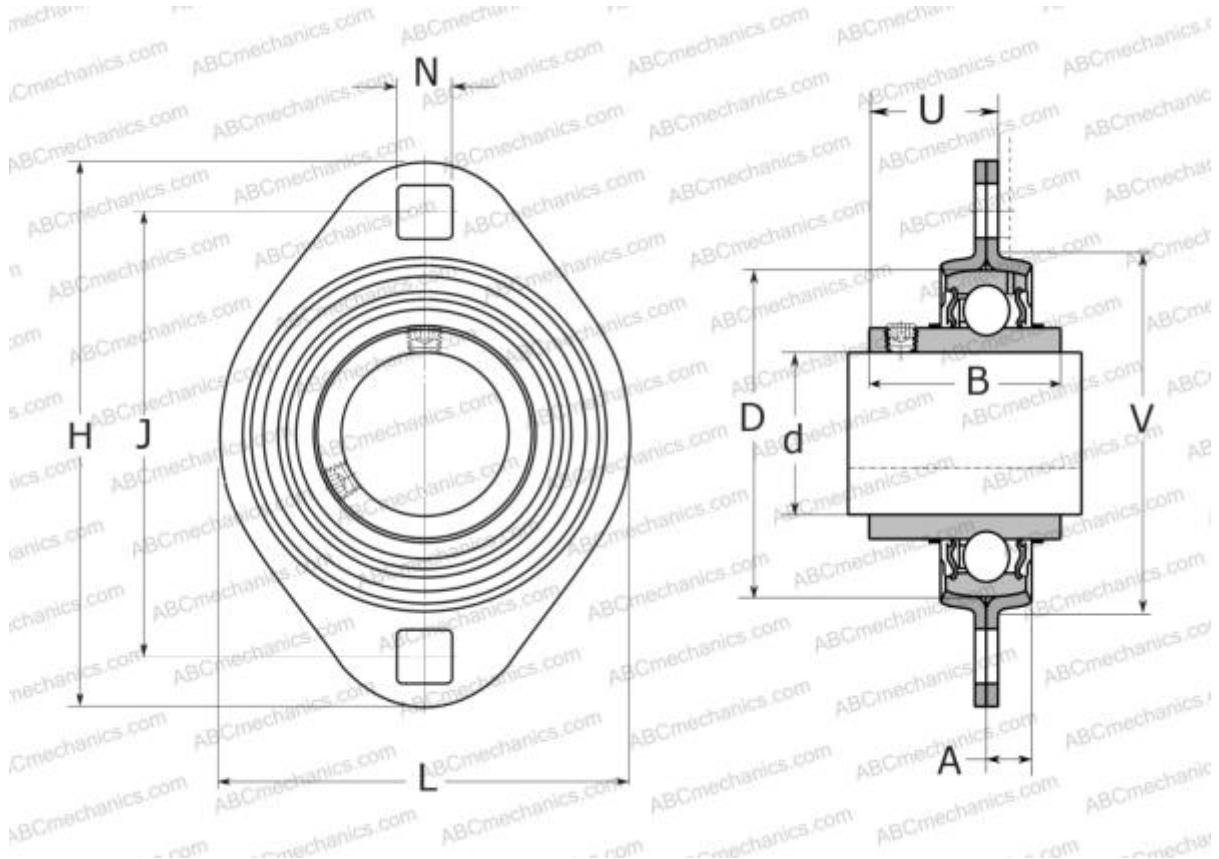

Technical specification

DIMENSIONS, MM

d	35,000
D	72,000
B	42,900
H	122,000
A	10,000
J	100,000
H1	94,000
N	11,000
U	27,900
V	81,000

WEIGHT, KG 0,650

Bearing	YAR 207-2F
Housing	PFT 72

MANUFACTURER

[SKF](#)

CALCULATION DATA

Basic dynamic load rating, C	25,500 kN
Basic static load rating, Co	15,300 kN
Fatigue load limit, Pu	0,655 kN