

PFT 40 TR SKF

Ball bearing units

TYPE: Housing units, Two-bolt flanged housing units, Sheet steel housing, Radial insert ball bearing with grub screws in inner ring, Type PFT..TR (SKF)

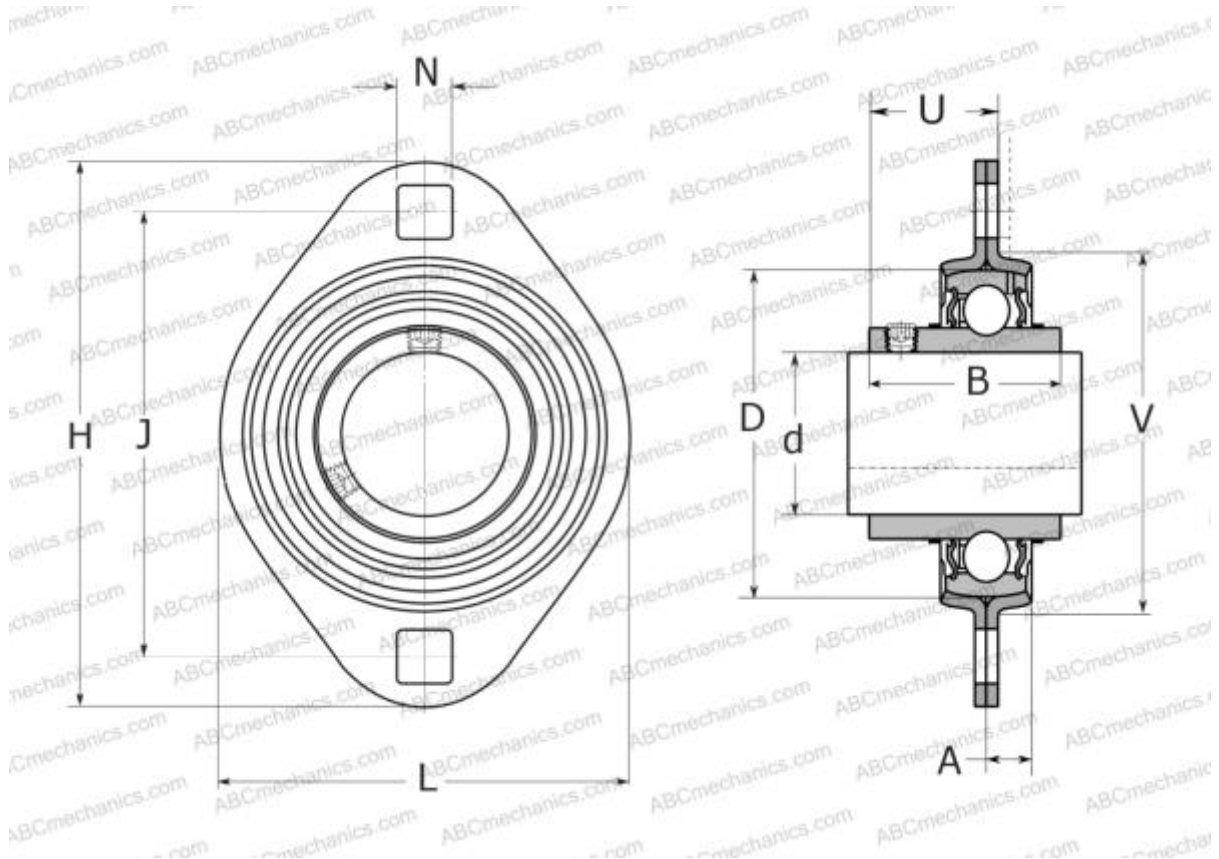

Technical specification

DIMENSIONS, MM

d	40,000
D	80,000
B	49,200
H	148,000
A	10,000
J	119,000
H1	104,000
N	13,500
U	33,700
V	91,000

WEIGHT, KG 0,900

Bearing	YAR 208-2RF
Housing	PFT 80

MANUFACTURER

[SKF](#)

CALCULATION DATA

Basic dynamic load rating, C	30,700 kN
Basic static load rating, Co	19,000 kN
Fatigue load limit, Pu	0,800 kN