

PFT 17 RM SKF

Ball bearing units

TYPE: Housing units, Two-bolt flanged housing units, Sheet steel housing, Radial insert ball bearing with grub screws in inner ring, Type PFT..RM (SKF)

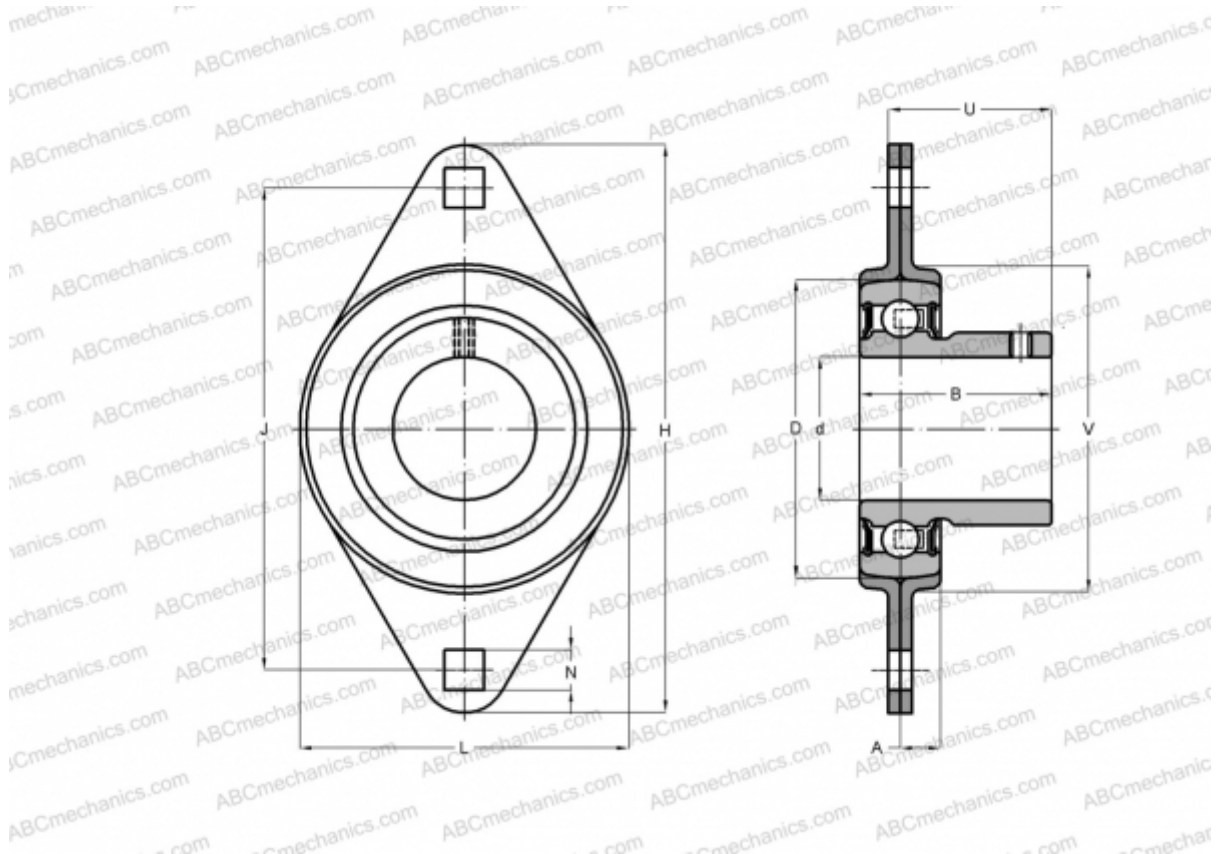

Technical specification

DIMENSIONS, MM

d	17,000
D	40,000
B	22,100
H	81,000
A	7,000
J	63,000
H1	59,000
N	7,100
U	17,900
V	49,000

WEIGHT, KG 0,160

Bearing	YAT 203
Housing	PFT 40

MANUFACTURER

[SKF](#)

CALCULATION DATA

Basic dynamic load rating, C	9,560 kN
Basic static load rating, Co	4,750 kN
Fatigue load limit, Pu	0,200 kN