

## PFT 25 RM SKF

Ball bearing units

TYPE: Housing units, Two-bolt flanged housing units, Sheet steel housing, Radial insert ball bearing with grub screws in inner ring, Type PFT..RM (SKF)

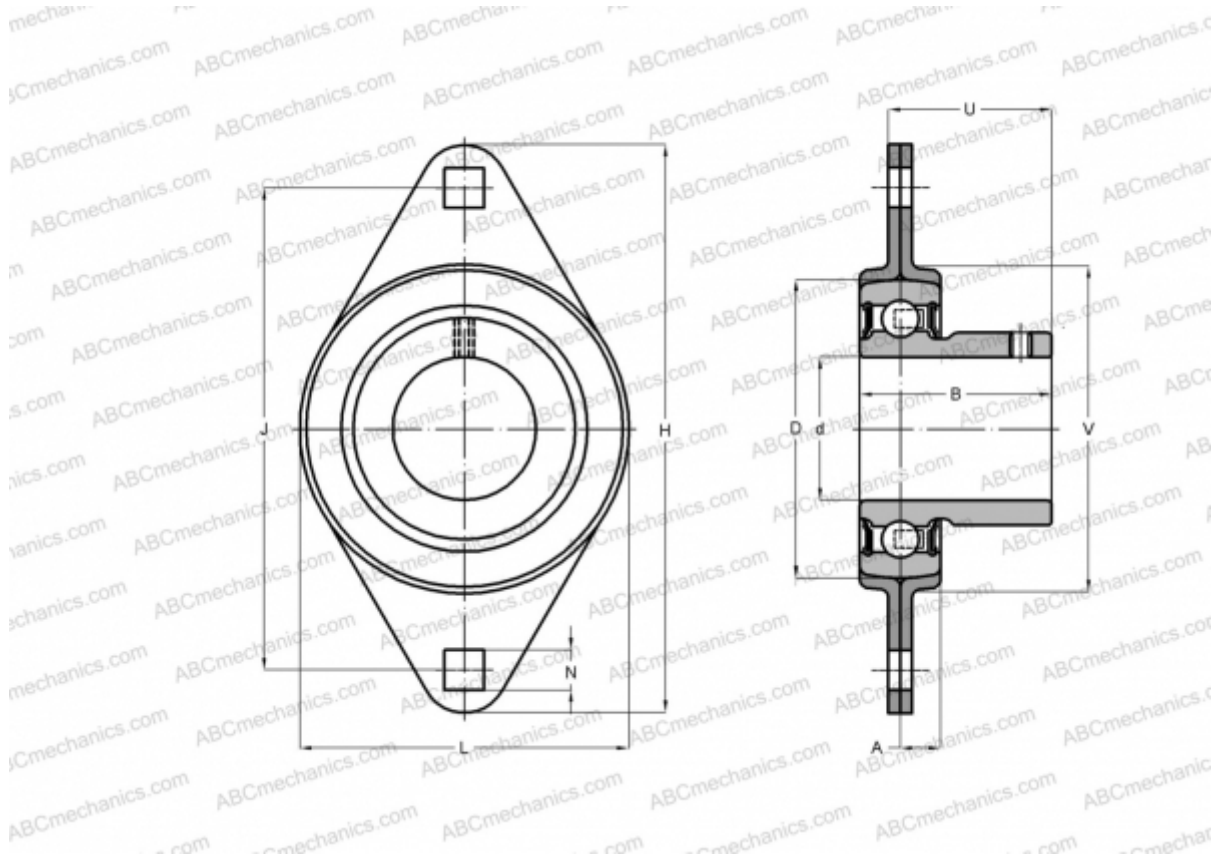

### Technical specification

#### DIMENSIONS, MM

d	25,000
D	52,000
B	27,200
H	95,000
A	9,000
J	76,000
H1	71,000
N	8,700
U	21,500
V	60,000

#### WEIGHT, KG

0,250

Bearing	YAT 205
Housing	PFT 52

#### MANUFACTURER

[SKF](#)

#### CALCULATION DATA

Basic dynamic load rating, C	14,000 kN
Basic static load rating, Co	7,800 kN
Fatigue load limit, Pu	0,335 kN