

## PFD 15 TF SKF

Ball bearing units

TYPE: Housing units, Three-bolt flanged housing units, Sheet steel housing, Radial insert ball bearing with grub screws in inner ring, Type PFD..TF (SKF)

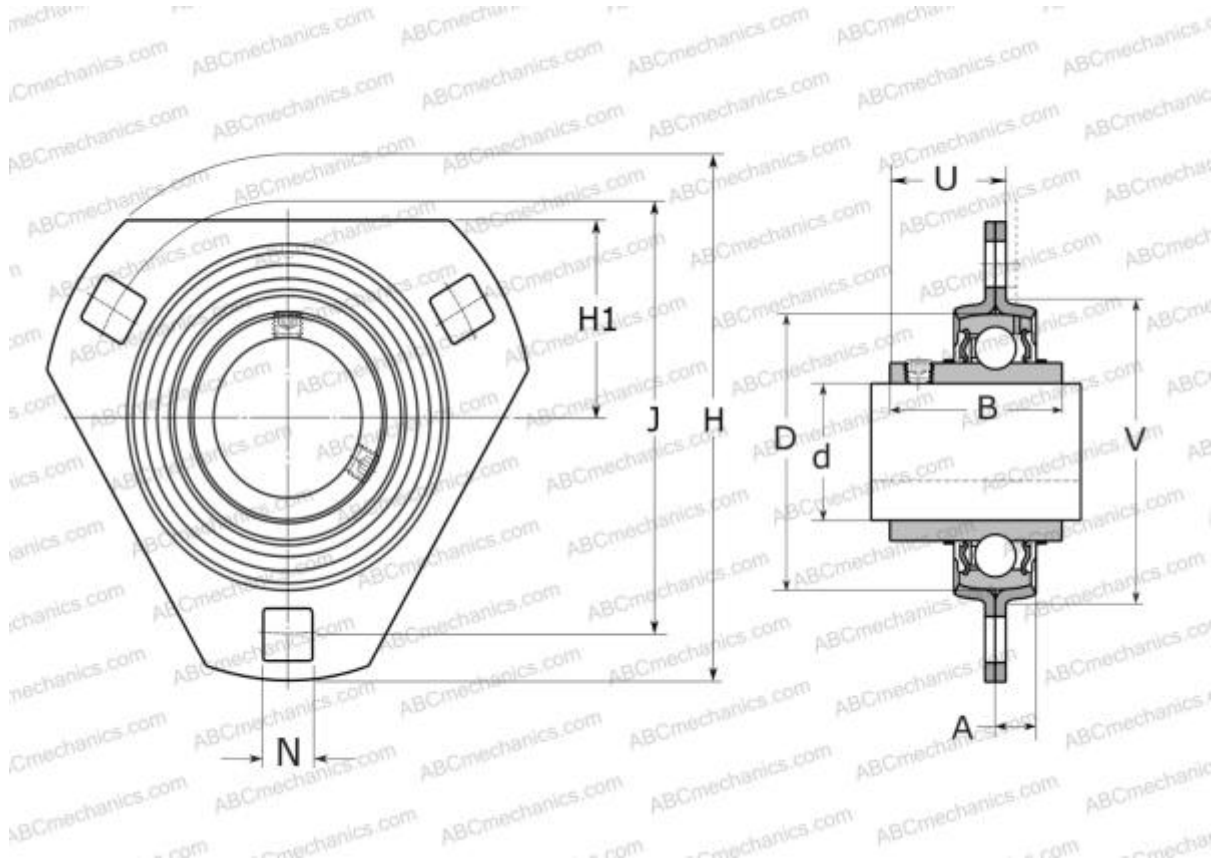

### Technical specification

#### DIMENSIONS, MM

d	15,000
D	40,000
B	27,400
H	81,000
A	7,000
J	63,000
H1	29,000
N	7,100
U	17,900
V	49,000

#### WEIGHT, KG

0,180

Bearing	YAR 203/15-2F
Housing	PFD 40

#### MANUFACTURER

[SKF](#)

#### CALCULATION DATA

Basic dynamic load rating, C	9,560 kN
Basic static load rating, Co	4,750 kN
Fatigue load limit, Pu	0,200 kN