

PFD 40 RM SKF

Ball bearing units

TYPE: Housing units, Three-bolt flanged housing units, Sheet steel housing, Radial insert ball bearing with grub screws in inner ring, Type PFD..RM (SKF)

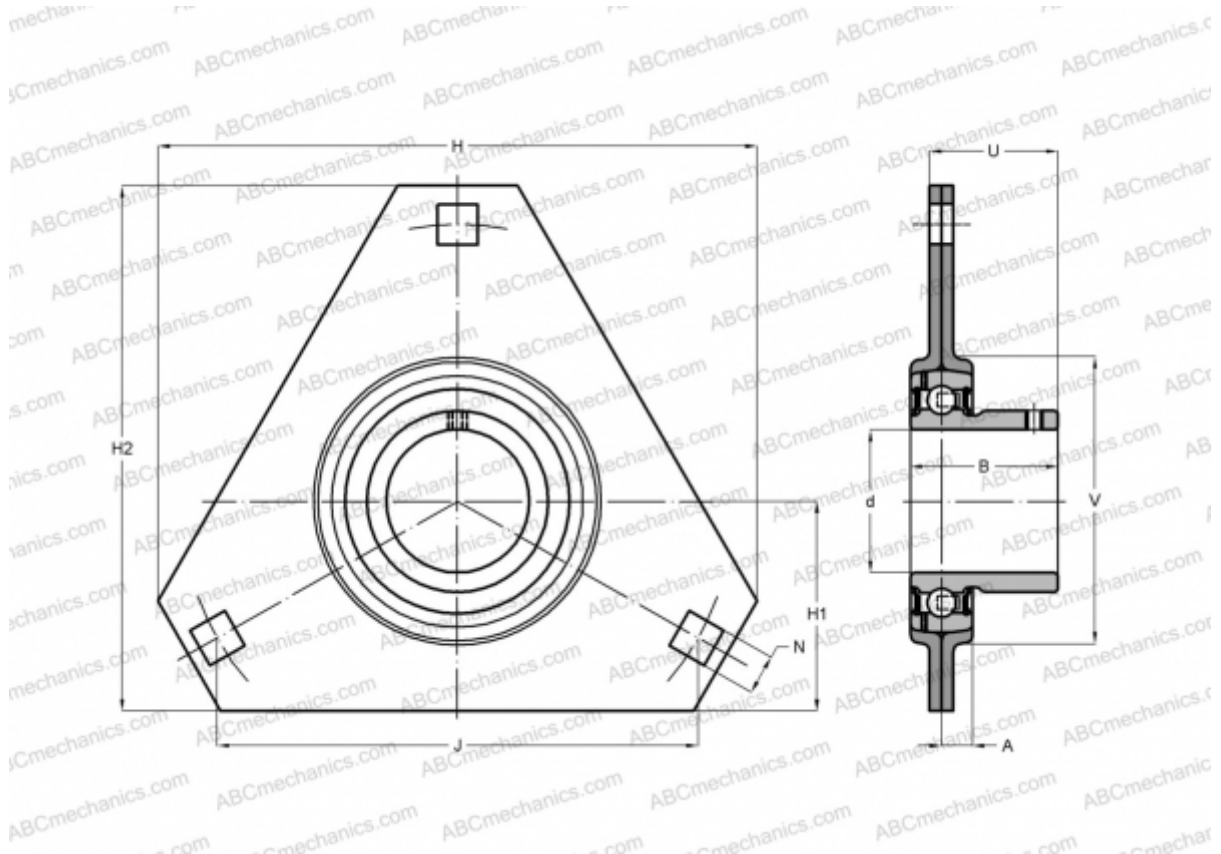

Technical specification

DIMENSIONS, MM

d	40,000
D	80,000
B	36,000
H	148,000
A	10,000
J	119,000
H1	53,000
N	13,500
U	28,800
V	91,000

WEIGHT, KG

0,900

Bearing	YAT 208
Housing	PFD 80

MANUFACTURER

[SKF](#)

CALCULATION DATA

Basic dynamic load rating, C	30,700 kN
Basic static load rating, Co	19,000 kN
Fatigue load limit, Pu	0,800 kN