

PF 15 TF SKF

Ball bearing units

TYPE: Housing units, Three/four-bolt flanged housing units, Sheet steel housing, Radial insert ball bearing with grub screws in inner ring, Type PF..TF (SKF)

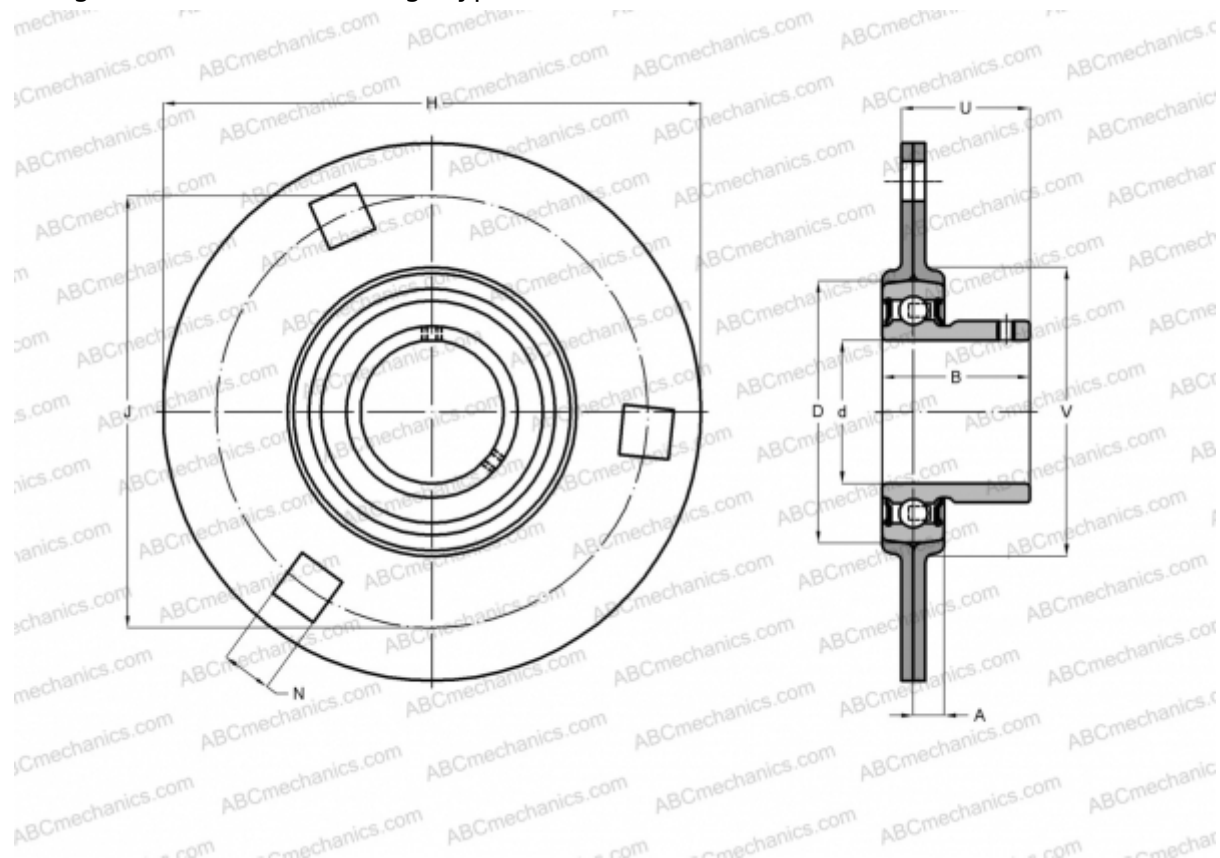

Technical specification

DIMENSIONS, MM

d	15,000
D	40,000
B	27,400
H	81,000
A	7,000
J	63,000
N	7,100
U	17,900
V	49,000

WEIGHT, KG 0,250

Bearing	YAR 203/15-2F
Housing	PF 40

MANUFACTURER

[SKF](#)

CALCULATION DATA

Basic dynamic load rating, C	9,560 kN
Basic static load rating, Co	4,750 kN
Fatigue load limit, Pu	0,200 kN