

PF 25 TF SKF

Ball bearing units

TYPE: Housing units, Three/four-bolt flanged housing units, Sheet steel housing, Radial insert ball bearing with grub screws in inner ring, Type PF..TF (SKF)

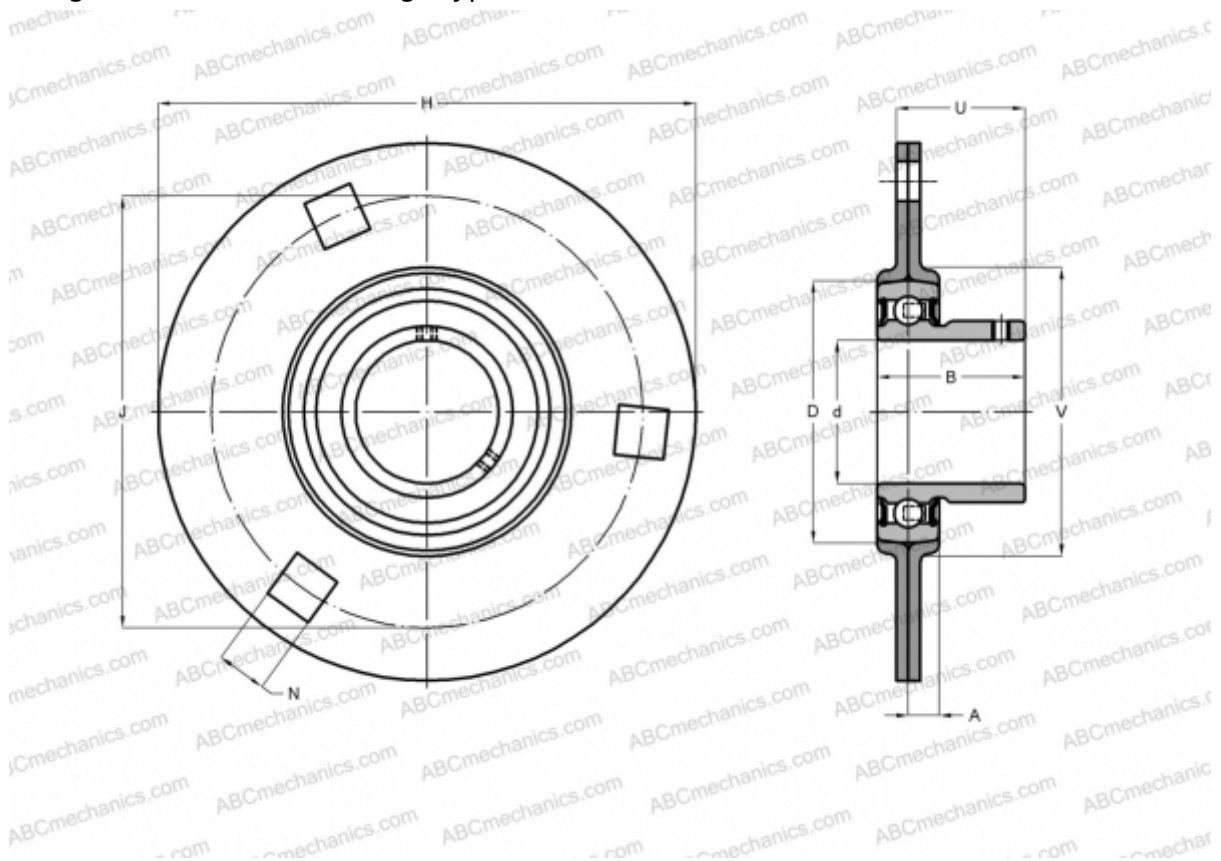

Technical specification

DIMENSIONS, MM

d	25,000
D	52,000
B	34,100
H	95,000
A	9,000
J	76,000
N	8,700
U	21,800
V	60,000

WEIGHT, KG 0,360

Bearing	YAR 205-2F
Housing	PF 52

MANUFACTURER

[SKF](#)

CALCULATION DATA

Basic dynamic load rating, C	14,000 kN
Basic static load rating, Co	7,800 kN
Fatigue load limit, Pu	0,335 kN