

PF 45 TR SKF

Ball bearing units

TYPE: Housing units, Three/four-bolt flanged housing units, Sheet steel housing, Radial insert ball bearing with grub screws in inner ring, Type PF..TR (SKF)

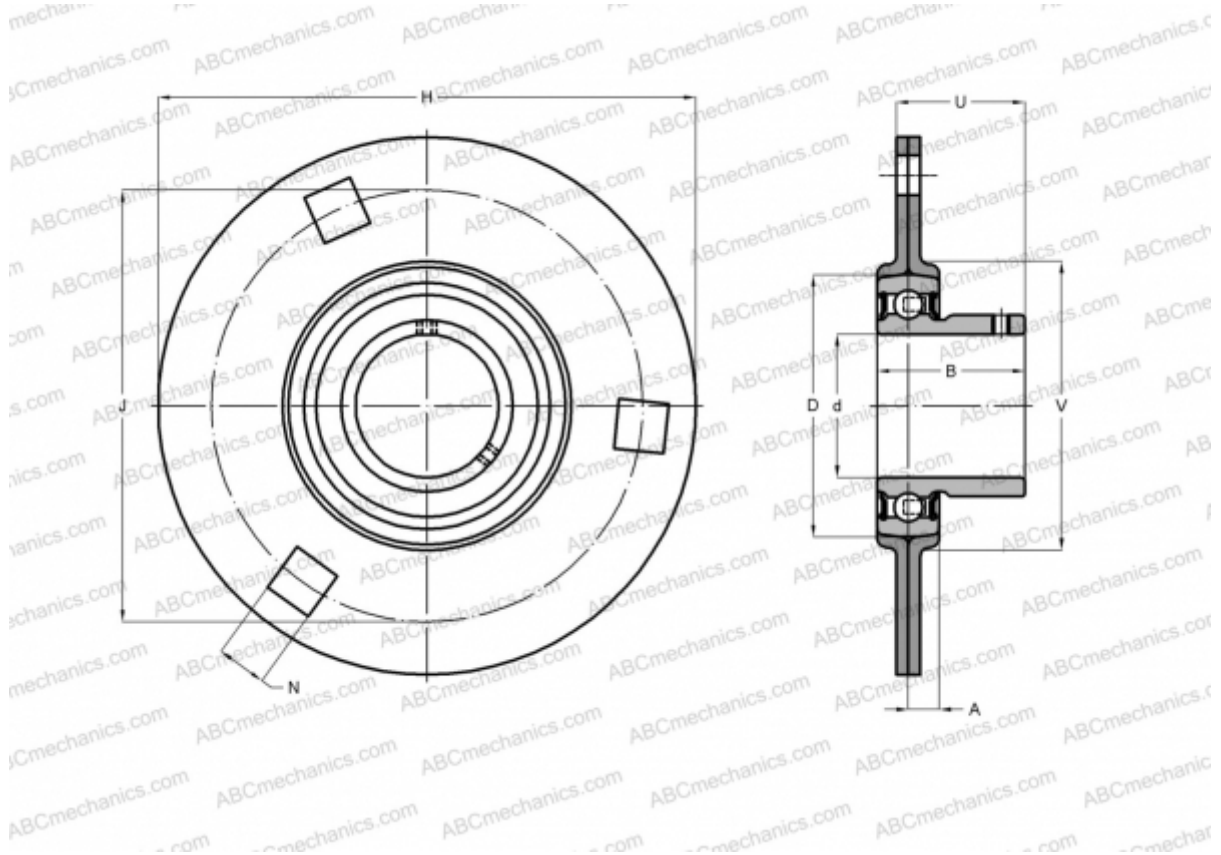

Technical specification

DIMENSIONS, MM

d	45,000
D	85,000
B	49,200
H	149,000
A	10,500
J	120,600
N	13,500
U	33,700
V	97,000

WEIGHT, KG 1,350

Bearing	YAR 209-2RF
Housing	PF 85

MANUFACTURER

[SKF](#)

CALCULATION DATA

Basic dynamic load rating, C	33,200 kN
Basic static load rating, Co	21,600 kN
Fatigue load limit, Pu	0,915 kN