

PFT 17 FM SKF

Ball bearing units

TYPE: Housing units, Two-bolt flanged housing units, Sheet steel housing, Radial insert ball bearing with eccentric locking collar, Type PFT..FM (SKF)

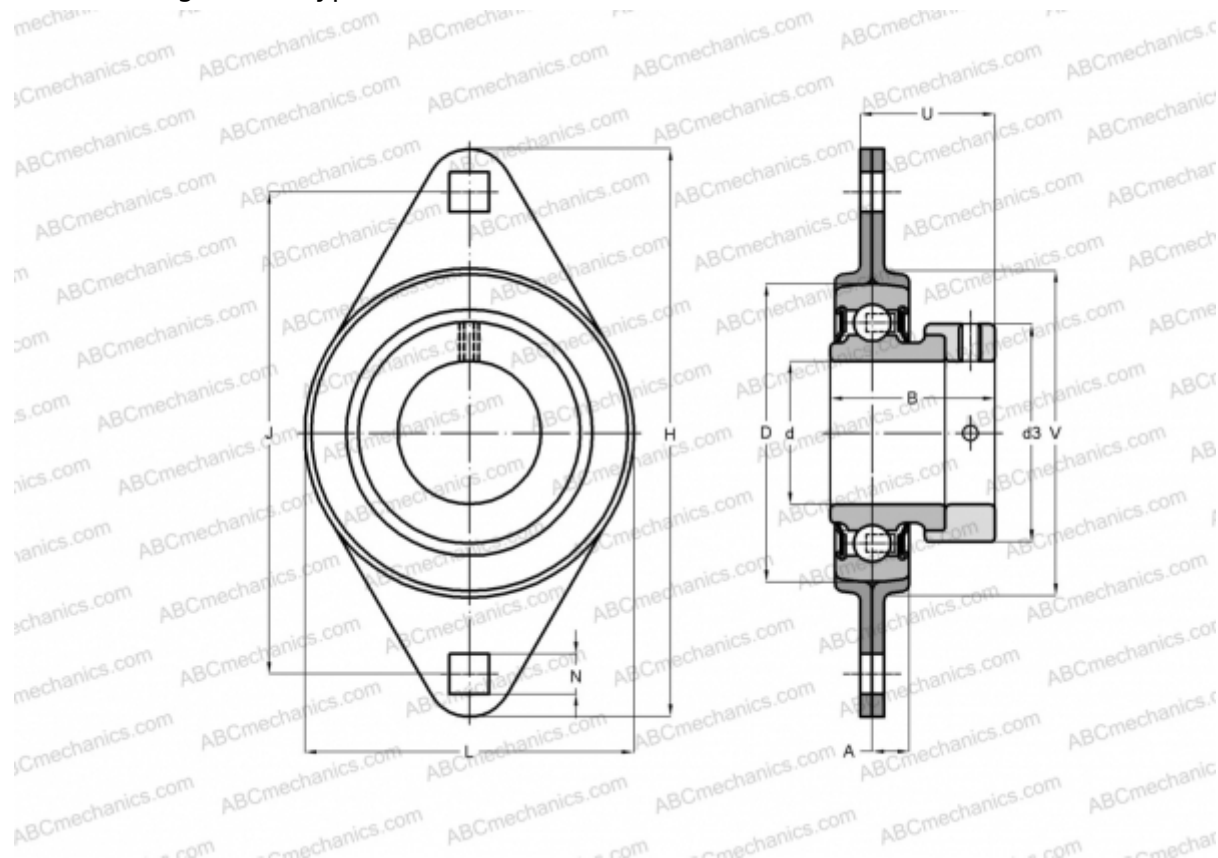

Technical specification

DIMENSIONS, MM

d	17,000
D	40,000
B	28,600
L	59,000
H	81,000
A	7,000
J	63,000
N	7,100
d3	27,200
U	24,100
V	49,000

WEIGHT, KG 0,190

Bearing YET 203

Housing PFT 40

MANUFACTURER

[SKF](#)

CALCULATION DATA

Basic dynamic load rating, C	9,560 kN
Basic static load rating, Co	4,750 kN
Fatigue load limit, Pu	0,200 kN