

## PFT 30 FM SKF

Ball bearing units

TYPE: Housing units, Two-bolt flanged housing units, Sheet steel housing, Radial insert ball bearing with eccentric locking collar, Type PFT..FM (SKF)

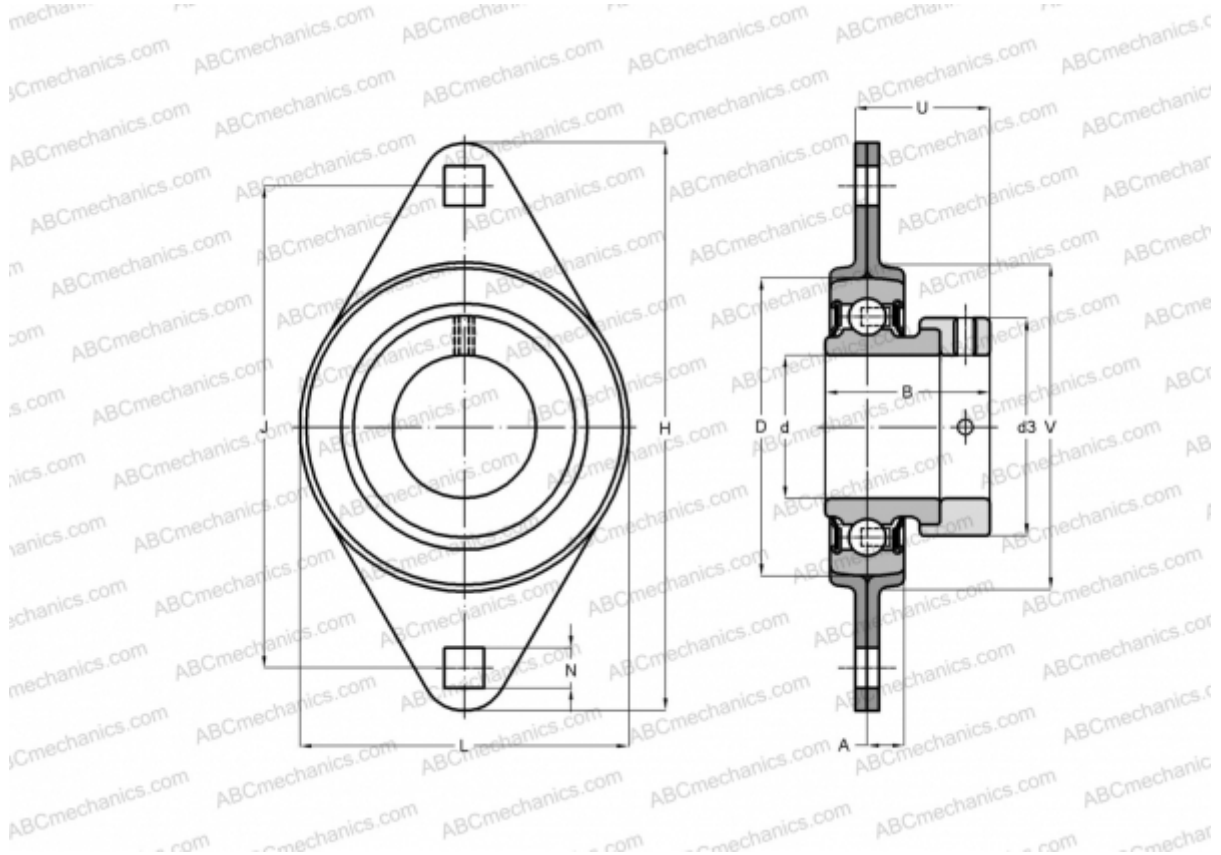

### Technical specification

#### DIMENSIONS, MM

d	30,000
D	62,000
B	35,700
L	84,000
H	112,000
A	9,500
J	90,500
N	10,500
d3	44,100
U	29,200
V	71,000

**WEIGHT, KG** 0,460

Bearing YET 206

Housing

PFT 62

#### MANUFACTURER

[SKF](#)

#### CALCULATION DATA

Basic dynamic load rating, C	19,500 kN
Basic static load rating, Co	11,200 kN
Fatigue load limit, Pu	0,475 kN