

PFD 30 WF SKF

Ball bearing units

TYPE: Housing units, Three-bolt flanged housing units, Sheet steel housing, Radial insert ball bearing with eccentric locking collar, Type PFD..WF (SKF)

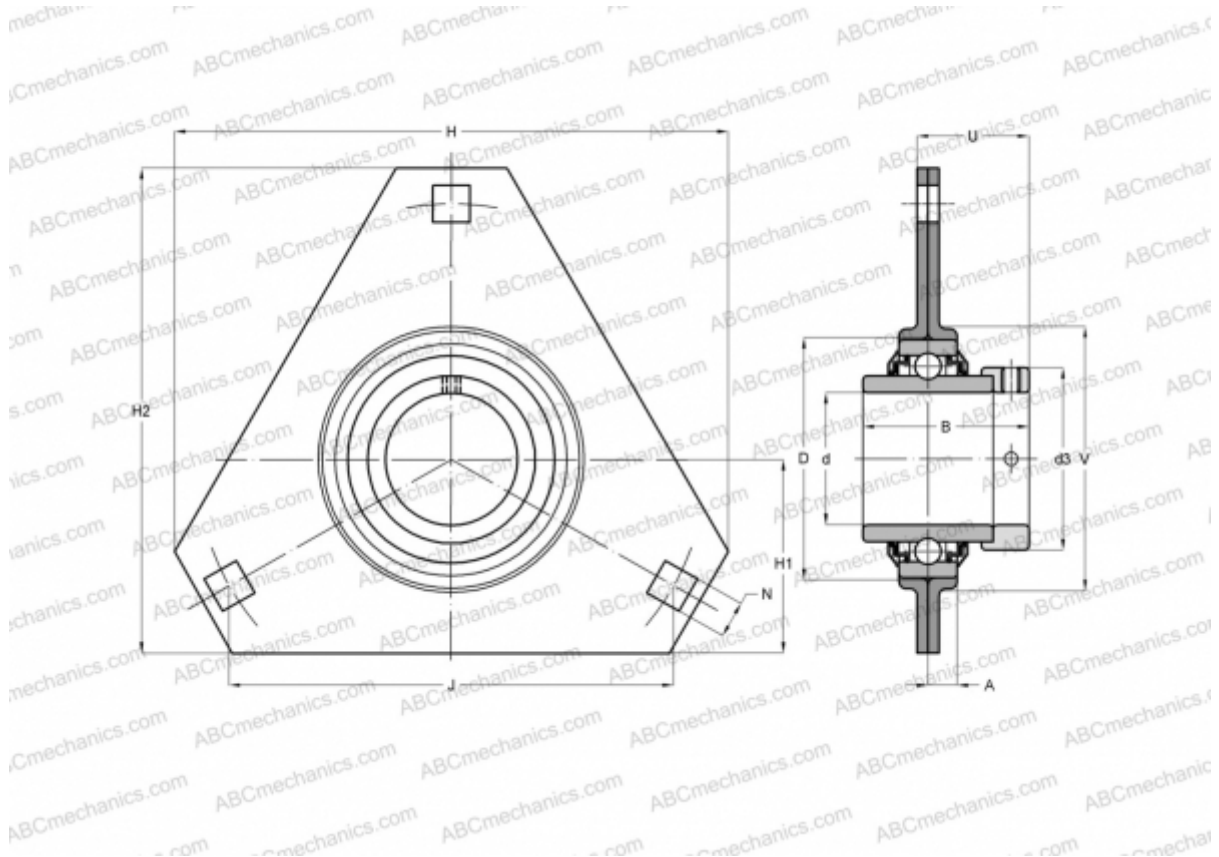

Technical specification

DIMENSIONS, MM

d	30,000
D	62,000
B	48,400
H	112,000
A	9,500
J	90,500
H1	38,000
N	10,500
d3	44,100
U	32,600
V	71,000

WEIGHT, KG 0,540

Bearing YEL 206-2F

Housing

PFD 62

MANUFACTURER

[SKF](#)

CALCULATION DATA

Basic dynamic load rating, C	19,500 kN
Basic static load rating, Co	11,200 kN
Fatigue load limit, Pu	0,475 kN