

PF 20 FM SKF

Ball bearing units

TYPE: Housing units, Three/four-bolt flanged housing units, Sheet steel housing, Radial insert ball bearing with eccentric locking collar, Type PF..FM (SKF)

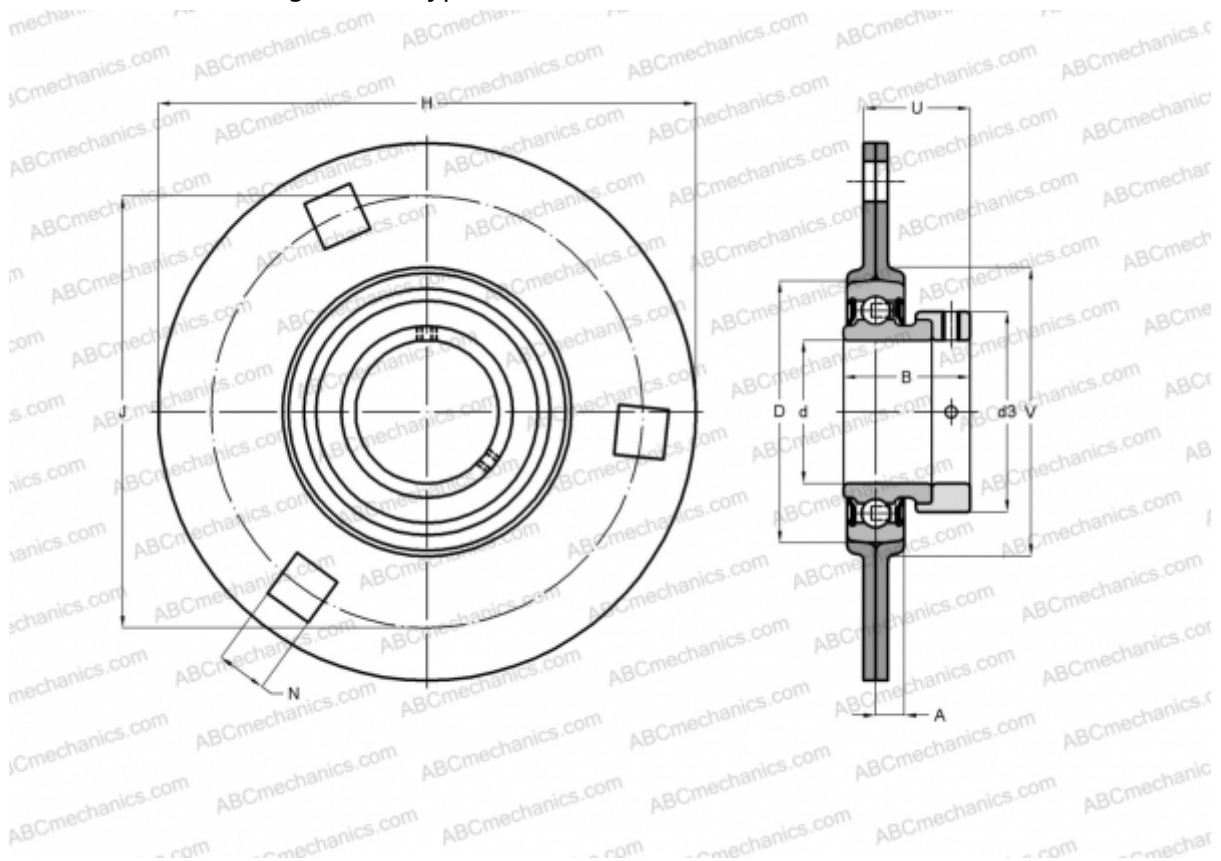

Technical specification

DIMENSIONS, MM

d	20,000
D	47,000
B	31,000
H	91,000
A	8,000
J	71,500
N	8,700
d3	32,400
U	25,500
V	55,000

WEIGHT, KG 0,300

Bearing	YET 204
Housing	PF 47

MANUFACTURER

[SKF](#)

CALCULATION DATA

Basic dynamic load rating, C	12,700 kN
Basic static load rating, Co	6,550 kN
Fatigue load limit, Pu	0,280 kN