

PF 25 FM SKF

Ball bearing units

TYPE: Housing units, Three/four-bolt flanged housing units, Sheet steel housing, Radial insert ball bearing with eccentric locking collar, Type PF..FM (SKF)

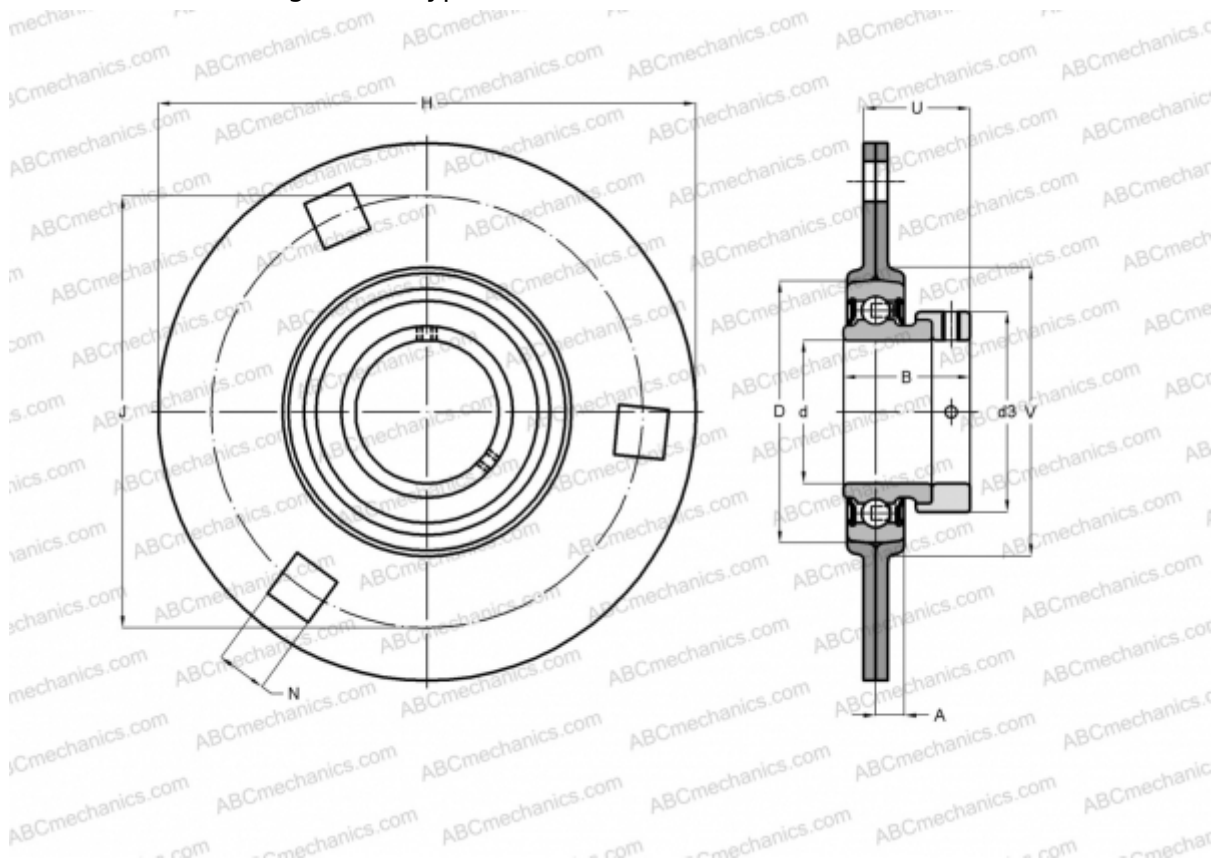

Technical specification

DIMENSIONS, MM

d	25,000
D	52,000
B	31,000
H	95,000
A	9,000
J	76,000
N	8,700
d3	37,400
U	25,500
V	60,000

WEIGHT, KG 0,350

Bearing	YET 205
Housing	PF 52

MANUFACTURER

[SKF](#)

CALCULATION DATA

Basic dynamic load rating, C	14,000 kN
Basic static load rating, Co	7,800 kN
Fatigue load limit, Pu	0,335 kN