

PF 35 FM SKF

Ball bearing units

TYPE: Housing units, Three/four-bolt flanged housing units, Sheet steel housing, Radial insert ball bearing with eccentric locking collar, Type PF..FM (SKF)

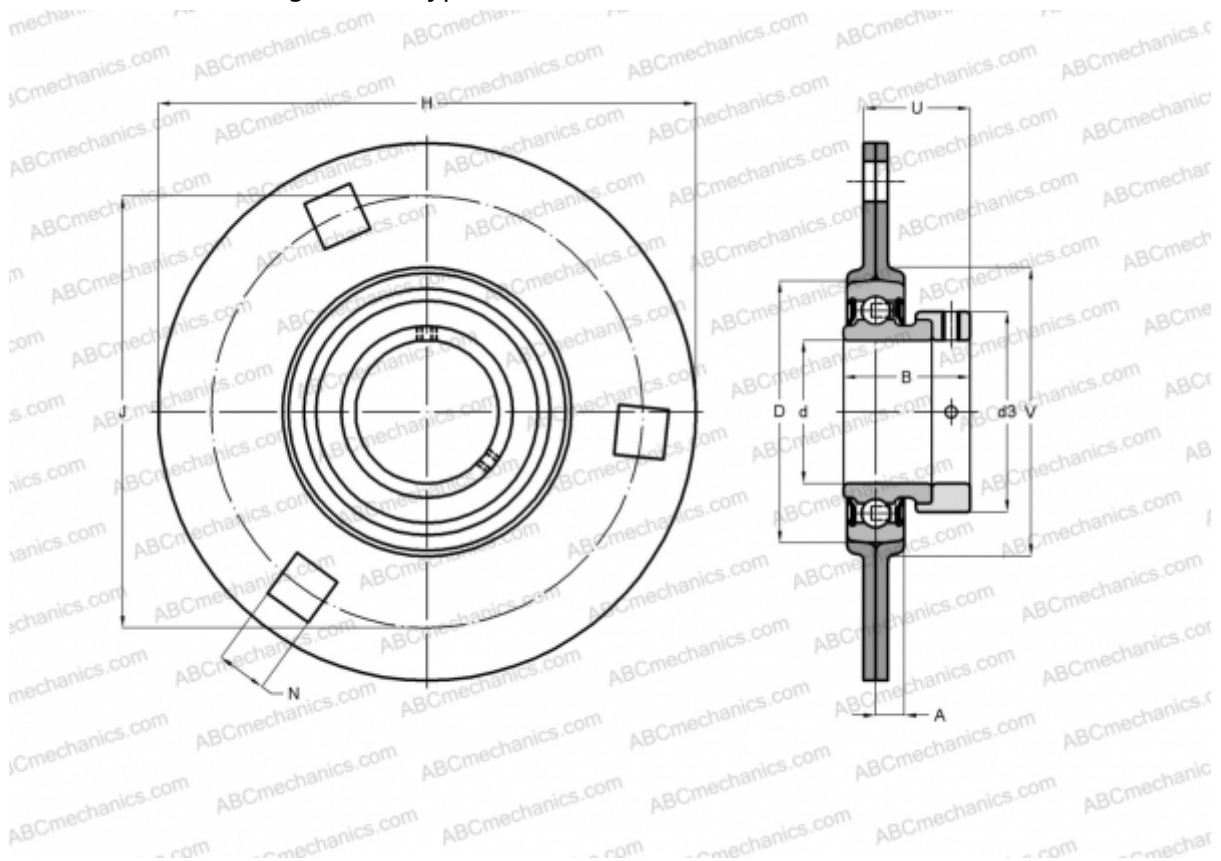

Technical specification

DIMENSIONS, MM

d	35,000
D	72,000
B	38,900
H	122,000
A	10,000
J	100,000
N	11,000
d3	51,100
U	31,900
V	81,000

WEIGHT, KG

	0,700
Bearing	YET 207
Housing	PF 72

MANUFACTURER

[SKF](#)

CALCULATION DATA

Basic dynamic load rating, C	25,500 kN
Basic static load rating, Co	15,300 kN
Fatigue load limit, Pu	0,655 kN