

## PF 25 WF SKF

Ball bearing units

TYPE: Housing units, Three/four-bolt flanged housing units, Sheet steel housing, Radial insert ball bearing with eccentric locking collar, Type PF..WF (SKF)

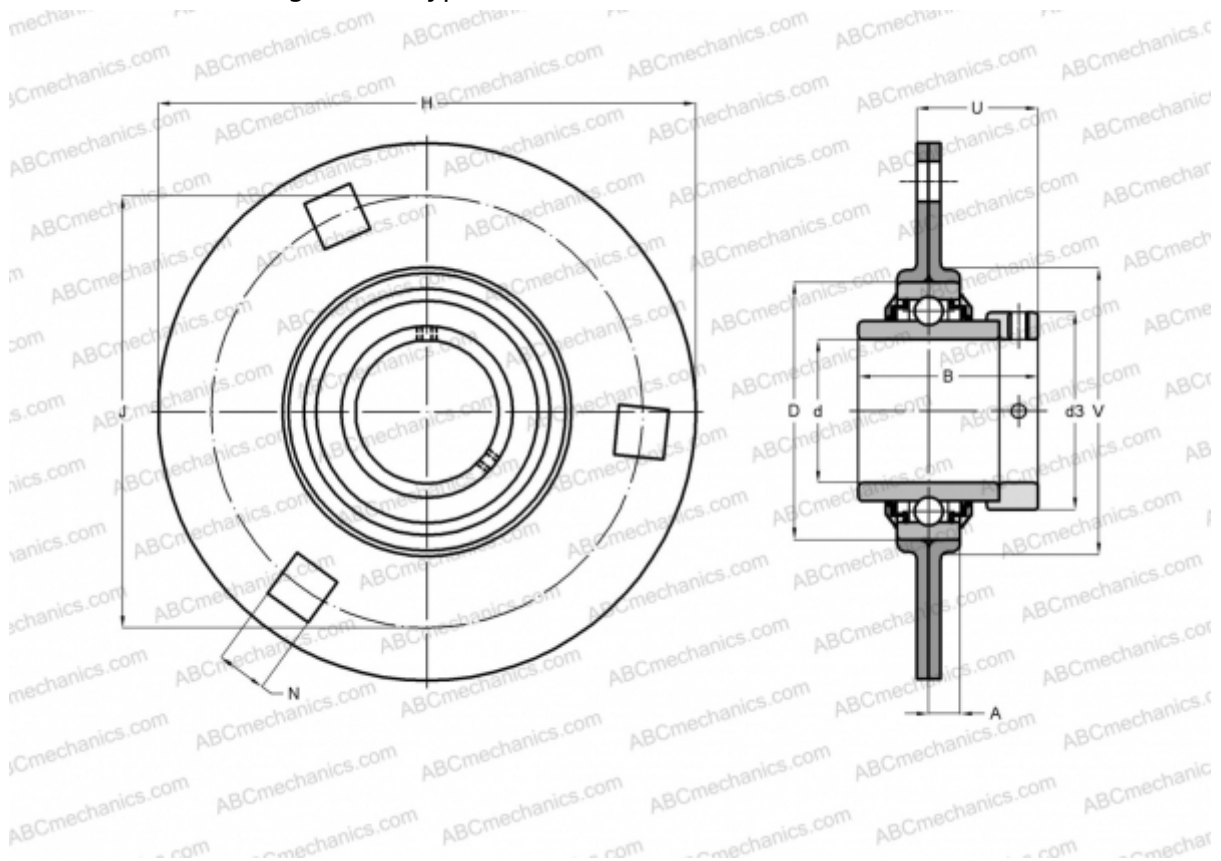

### Technical specification

#### DIMENSIONS, MM

d	25,000
D	52,000
B	44,400
H	95,000
A	9,000
J	76,000
N	8,700
d3	37,400
U	28,900
V	60,000

#### WEIGHT, KG

0,400

Bearing	YEL 205-2F
Housing	PF 52

#### MANUFACTURER

[SKF](#)

#### CALCULATION DATA

Basic dynamic load rating, C	14,000 kN
Basic static load rating, Co	7,800 kN
Fatigue load limit, Pu	0,335 kN