

PF 45 WF SKF

Ball bearing units

TYPE: Housing units, Three/four-bolt flanged housing units, Sheet steel housing, Radial insert ball bearing with eccentric locking collar, Type PF..WF (SKF)

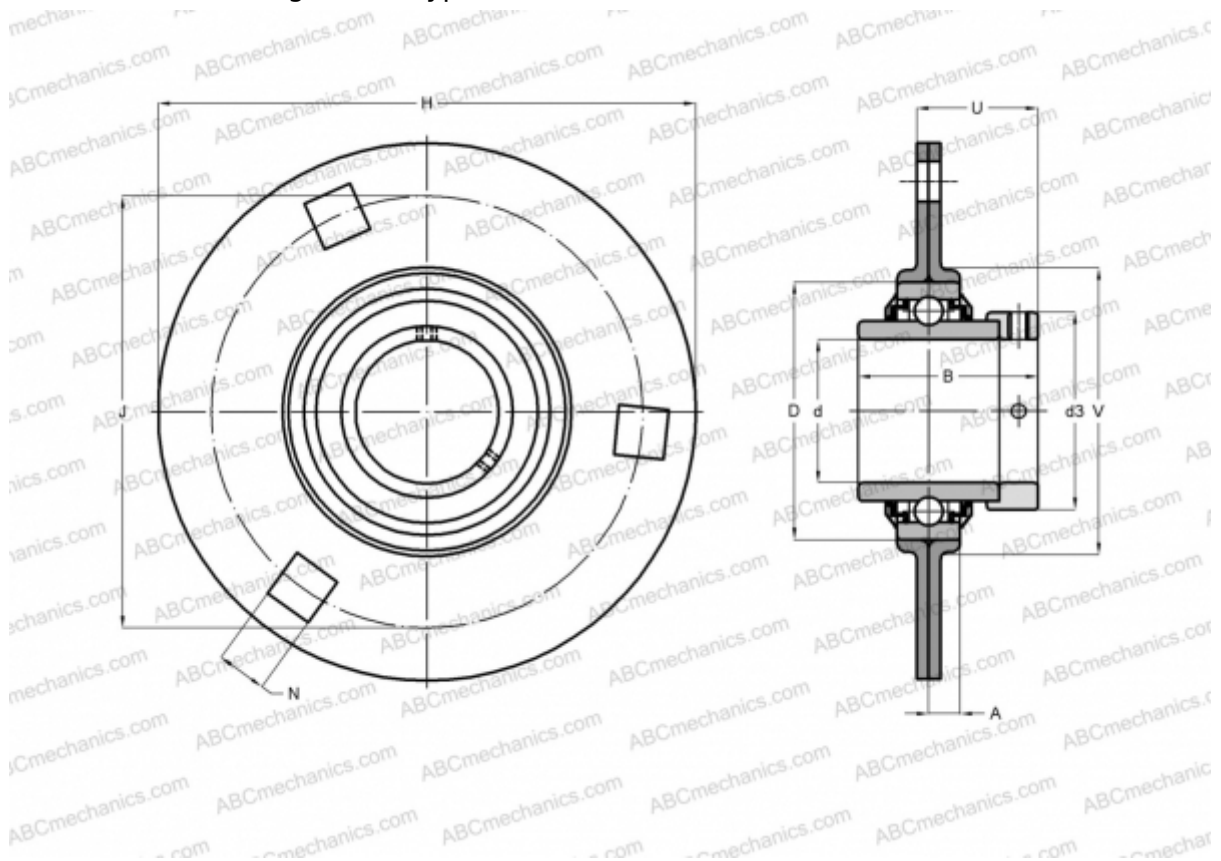

Technical specification

DIMENSIONS, MM

d	45,000
D	85,000
B	56,300
H	149,000
A	10,500
J	120,600
N	13,500
d3	62,000
U	38,400
V	97,000

WEIGHT, KG 1,400

Bearing	YEL 209-2F
Housing	PF 85

MANUFACTURER

[SKF](#)

CALCULATION DATA

Basic dynamic load rating, C	33,200 kN
Basic static load rating, Co	21,600 kN
Fatigue load limit, Pu	0,915 kN