

PF 50 WF SKF

Ball bearing units

TYPE: Housing units, Three/four-bolt flanged housing units, Sheet steel housing, Radial insert ball bearing with eccentric locking collar, Type PF..WF (SKF)

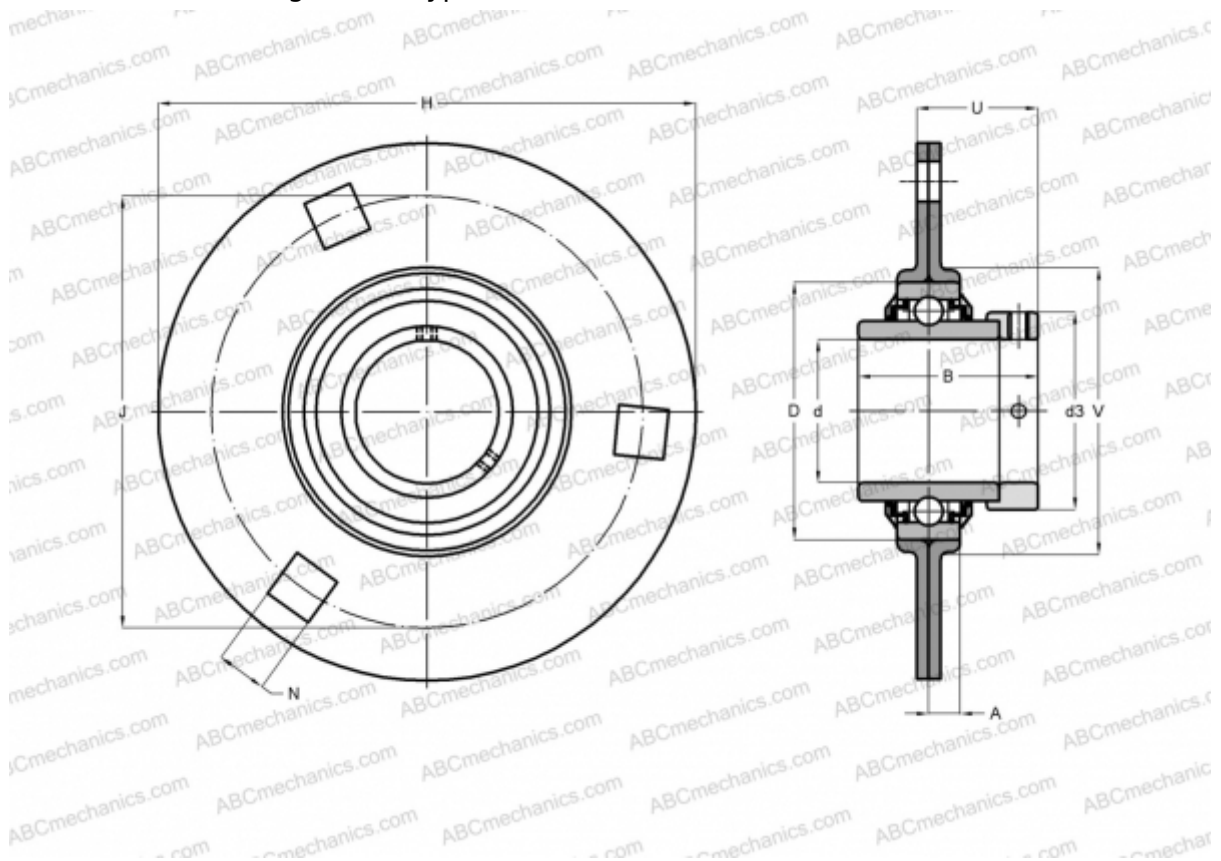

Technical specification

DIMENSIONS, MM

d	50,000
D	90,000
B	62,700
H	155,000
A	11,000
J	127,000
N	13,500
d3	67,200
U	42,100
V	102,000

WEIGHT, KG 1,650

Bearing	YEL 210-2F
Housing	PF 90

MANUFACTURER

[SKF](#)

CALCULATION DATA

Basic dynamic load rating, C	35,100 kN
Basic static load rating, Co	23,200 kN
Fatigue load limit, Pu	0,980 kN