

TU 20 TF SKF

Ball bearing units

TYPE: Housing units, Take-up housing units, Cast iron housing, Radial insert ball bearing with grub screws in inner ring, Type TU/TUJ..TF (SKF)

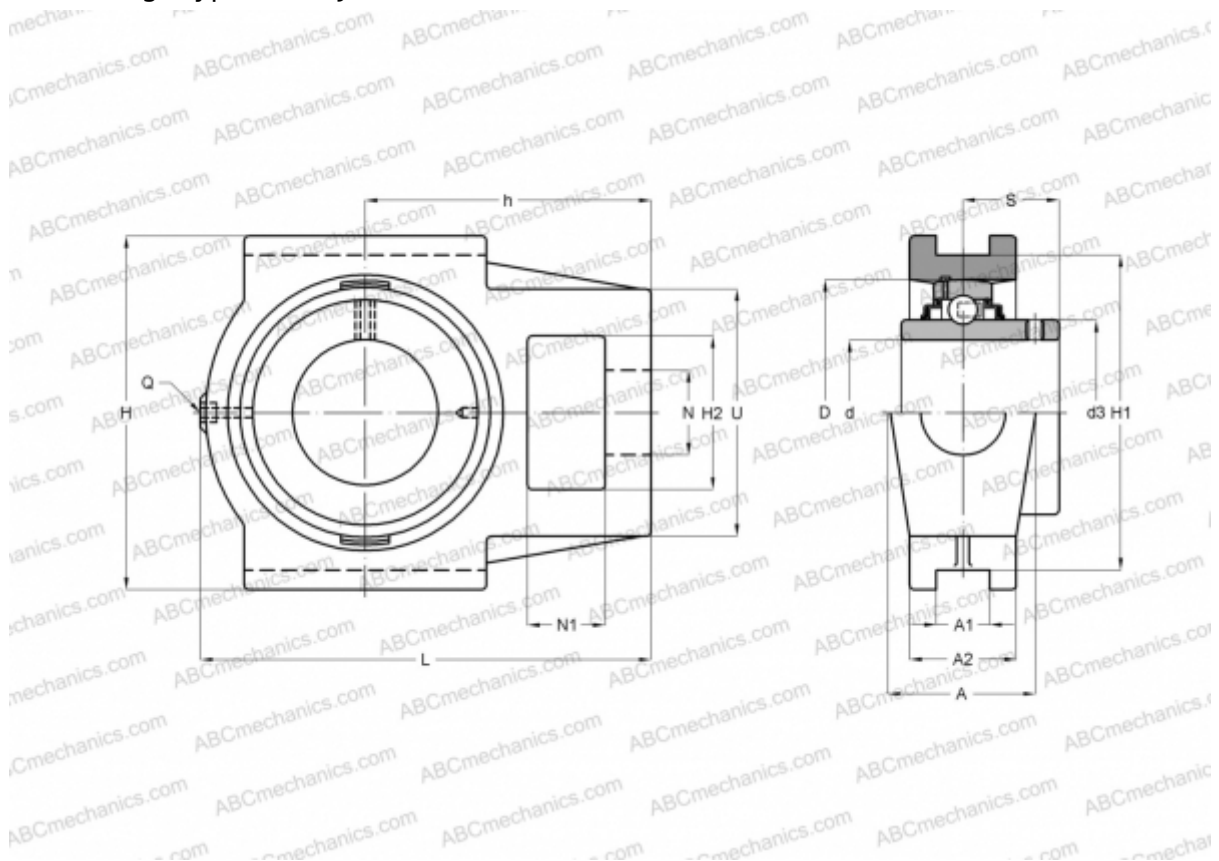

Technical specification

DIMENSIONS, MM

d	20,000
D	47,000
B	31,000
L	97,000
H	92,000
A	34,000
H2	32,000
A1	13,500
A2	25,000
H1	76,000
N	19,000
N1	16,000
S	18,300
U	54,000
h	62,000

WEIGHT, KG

	0,730
Bearing	YAR 204-2F
Housing	TU 504 M
Protective cover	ECY 204

MANUFACTURER

[SKF](#)

CALCULATION DATA

Basic dynamic load rating, C	12,700 kN
Basic static load rating, Co	6,550 kN
Fatigue load limit, Pu	0,280 kN
Limiting speed	8500 r/min