

## TU 45 TF SKF

Ball bearing units

TYPE: Housing units, Take-up housing units, Cast iron housing, Radial insert ball bearing with grub screws in inner ring, Type TU/TUJ..TF (SKF)

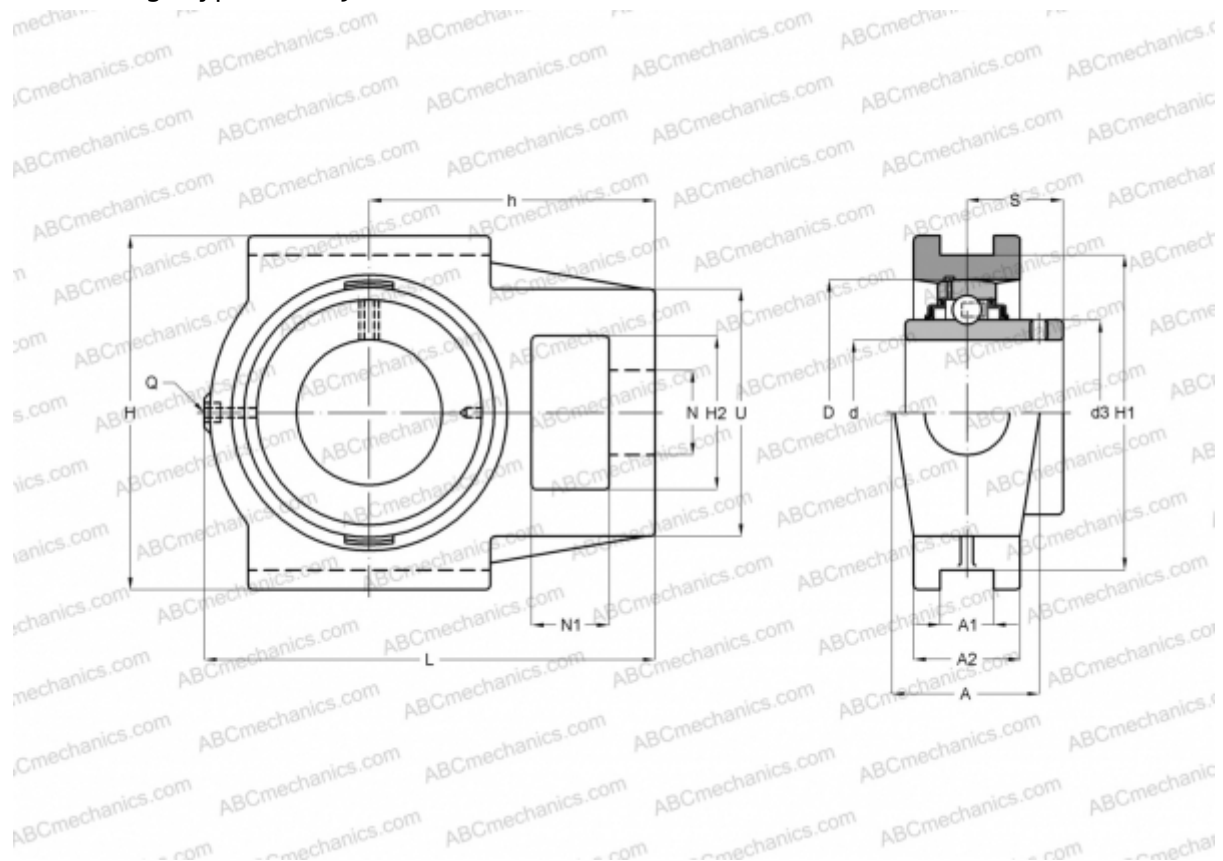

### Technical specification

#### DIMENSIONS, MM

d	45,000
D	85,000
B	49,200
L	144,000
H	117,000
A	49,000
H2	49,000
A1	17,500
A2	35,000
H1	101,000
N	29,000
N1	19,000
S	30,200
U	83,000
h	87,000

#### WEIGHT, KG

	2,300
Bearing	YAR 209-2F
Housing	TU 509 M
Protective cover	ECY 209

#### MANUFACTURER

[SKF](#)

#### CALCULATION DATA

Basic dynamic load rating, C	33,200 kN
Basic static load rating, Co	21,600 kN
Fatigue load limit, Pu	0,915 kN
Limiting speed	4300 r/min