

## TU 50 TF SKF

Ball bearing units

TYPE: Housing units, Take-up housing units, Cast iron housing, Radial insert ball bearing with grub screws in inner ring, Type TU/TUJ..TF (SKF)

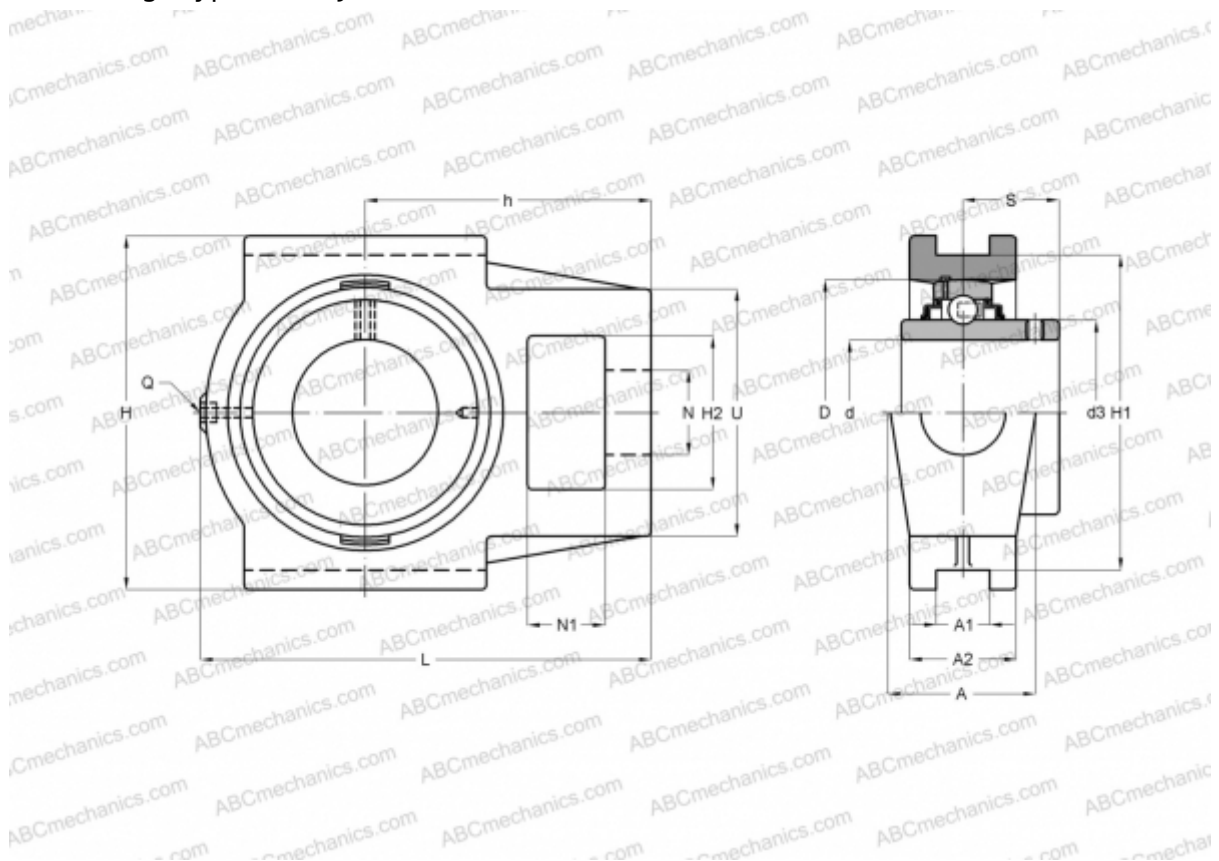

### Technical specification

#### DIMENSIONS, MM

d	50,000
D	90,000
B	51,600
L	149,000
H	117,000
A	49,000
H2	49,000
A1	17,500
A2	36,000
H1	101,000
N	29,000
N1	19,000
S	32,600
U	83,000
h	90,000

#### WEIGHT, KG

	2,400
Bearing	YAR 210-2F
Housing	TU 510 M
Protective cover	ECY 210

#### MANUFACTURER

[SKF](#)

#### CALCULATION DATA

Basic dynamic load rating, C	35,100 kN
Basic static load rating, Co	23,200 kN
Fatigue load limit, Pu	0,980 kN
Limiting speed	4000 r/min