

## TU 1. TF SKF

Ball bearing units

TYPE: Housing units, Take-up housing units, Cast iron housing, Radial insert ball bearing with grub screws in inner ring, Type TU..TF (SKF), inch

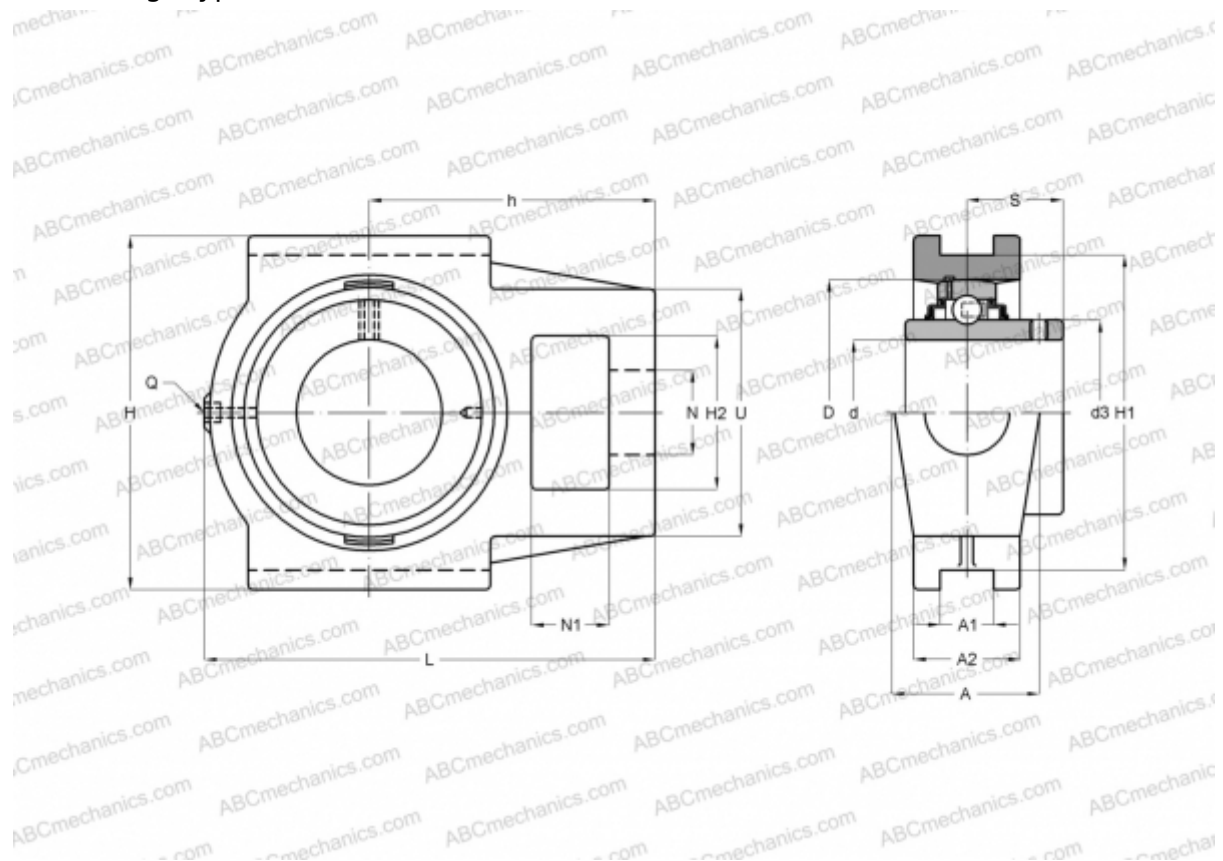

### Technical specification

#### DIMENSIONS, MM

d	25,400
D	52,000
B	34,100
L	100,000
H	91,000
A	34,000
H2	33,000
A1	13,500
A2	25,000
H1	76,000
N	19,000
N1	16,000
S	19,800
U	53,000
h	64,000

#### WEIGHT, KG

Bearing	0,760
Housing	YAR 205-100-TU 505 M

#### MANUFACTURER

[SKF](#)

#### CALCULATION DATA

Basic dynamic load rating, C	14,000 kN
Basic static load rating, Co	7,800 kN
Fatigue load limit, Pu	0,335 kN
Limiting speed	7000 r/min