

TU 1.1/8 TF SKF

Ball bearing units

TYPE: Housing units, Take-up housing units, Cast iron housing, Radial insert ball bearing with grub screws in inner ring, Type TU..TF (SKF), inch

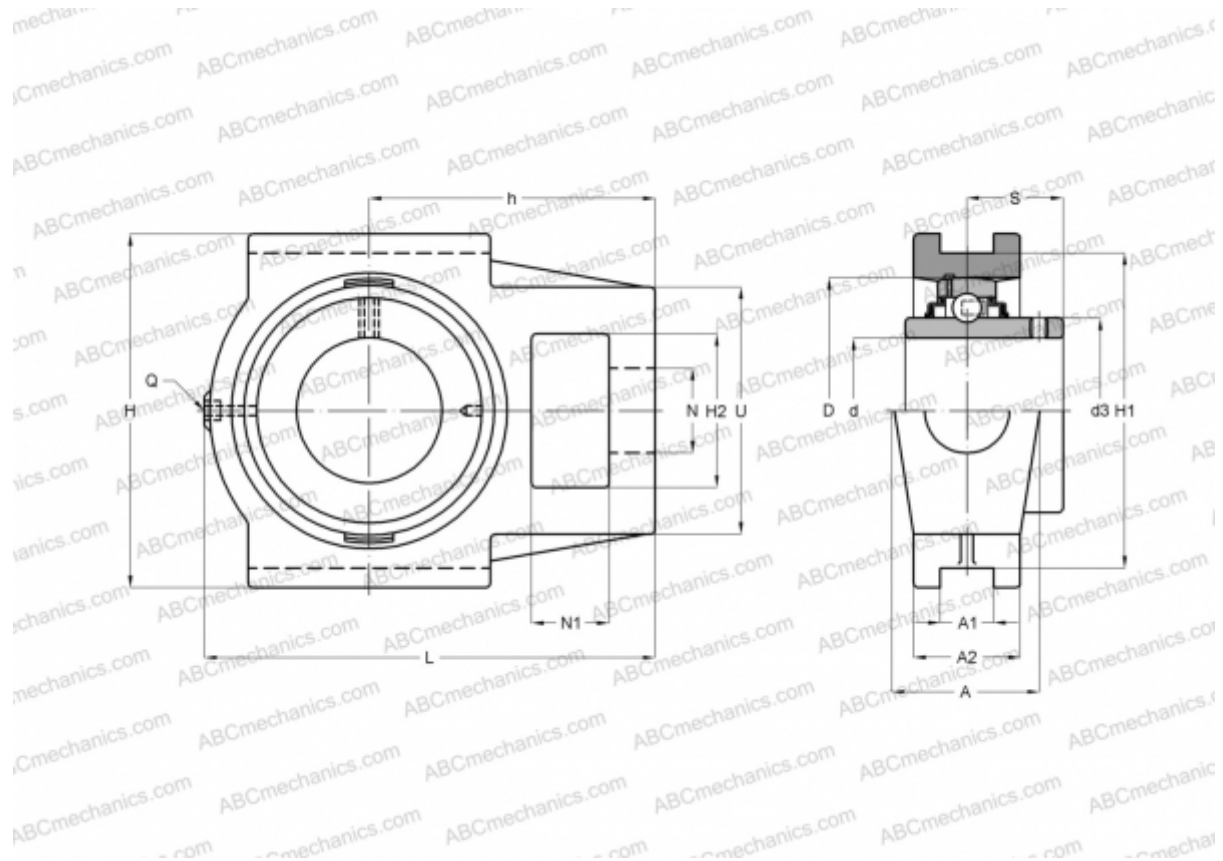

Technical specification

DIMENSIONS, MM

d	28,575
D	62,000
B	38,100
L	114,000
H	104,000
A	37,000
H2	37,000
A1	13,500
A2	28,000
H1	89,000
N	22,000
N1	16,000
S	22,200
U	56,000
h	70,000

WEIGHT, KG

	1,250
Bearing	YAR 206-102-
Housing	TU 506 U

MANUFACTURER

[SKF](#)

CALCULATION DATA

Basic dynamic load rating, C	19,500 kN
Basic static load rating, Co	11,200 kN
Fatigue load limit, Pu	0,475 kN
Limiting speed	6300 r/min