

TU 1.7/16 TF SKF

Ball bearing units

TYPE: Housing units, Take-up housing units, Cast iron housing, Radial insert ball bearing with grub screws in inner ring, Type TU..TF (SKF), inch

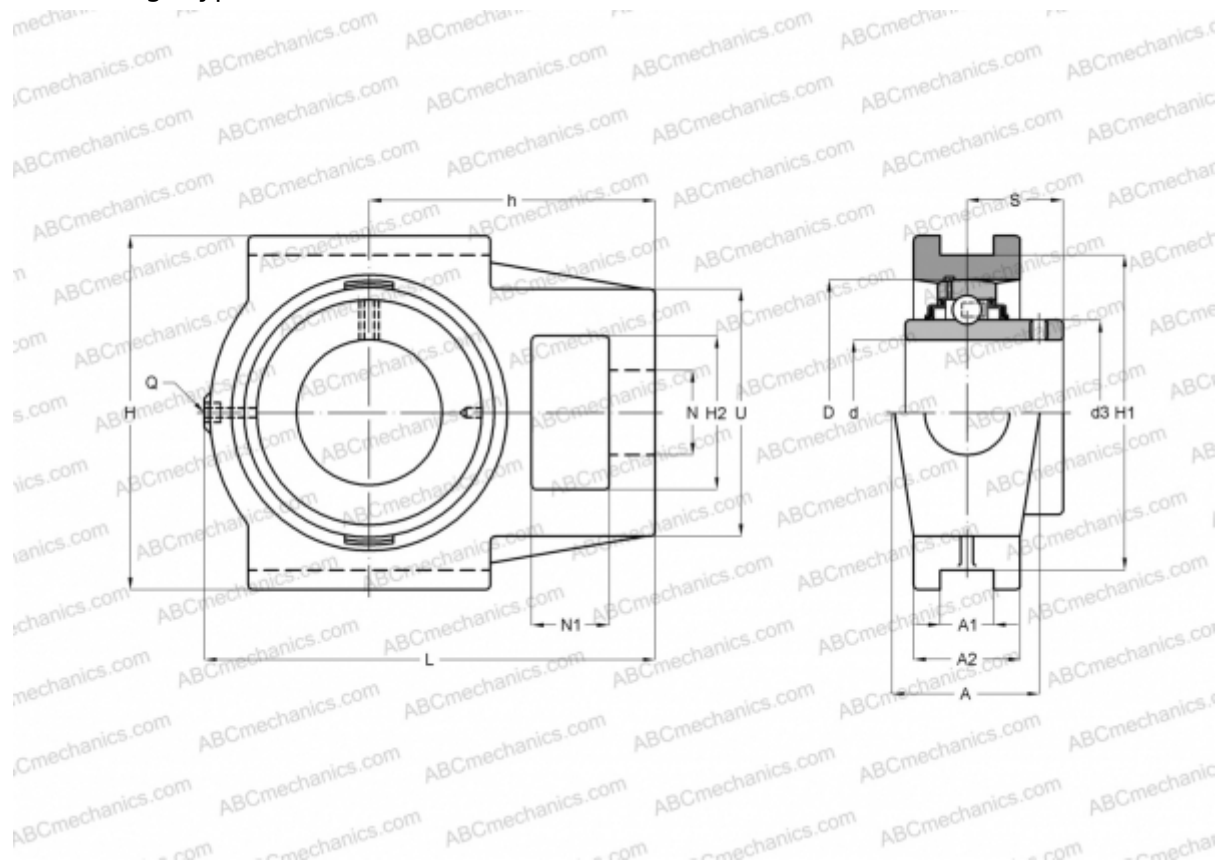

Technical specification

DIMENSIONS, MM

d	36,513
D	72,000
B	42,900
L	129,000
H	103,000
A	37,000
H2	38,000
A1	13,500
A2	30,000
H1	89,000
N	22,000
N1	17,000
S	25,400
U	64,000
h	78,000

WEIGHT, KG

	1,450
Bearing	YAR 207-107-
Housing	TU 507 U

MANUFACTURER

[SKF](#)

CALCULATION DATA

Basic dynamic load rating, C	25,500 kN
Basic static load rating, Co	15,300 kN
Fatigue load limit, Pu	0,655 kN
Limiting speed	5300 r/min