

## TU 20 FM SKF

Ball bearing units

TYPE: Housing units, Take-up housing units, Cast iron housing, Radial insert ball bearing with eccentric locking collar, Type TU..FM (SKF)

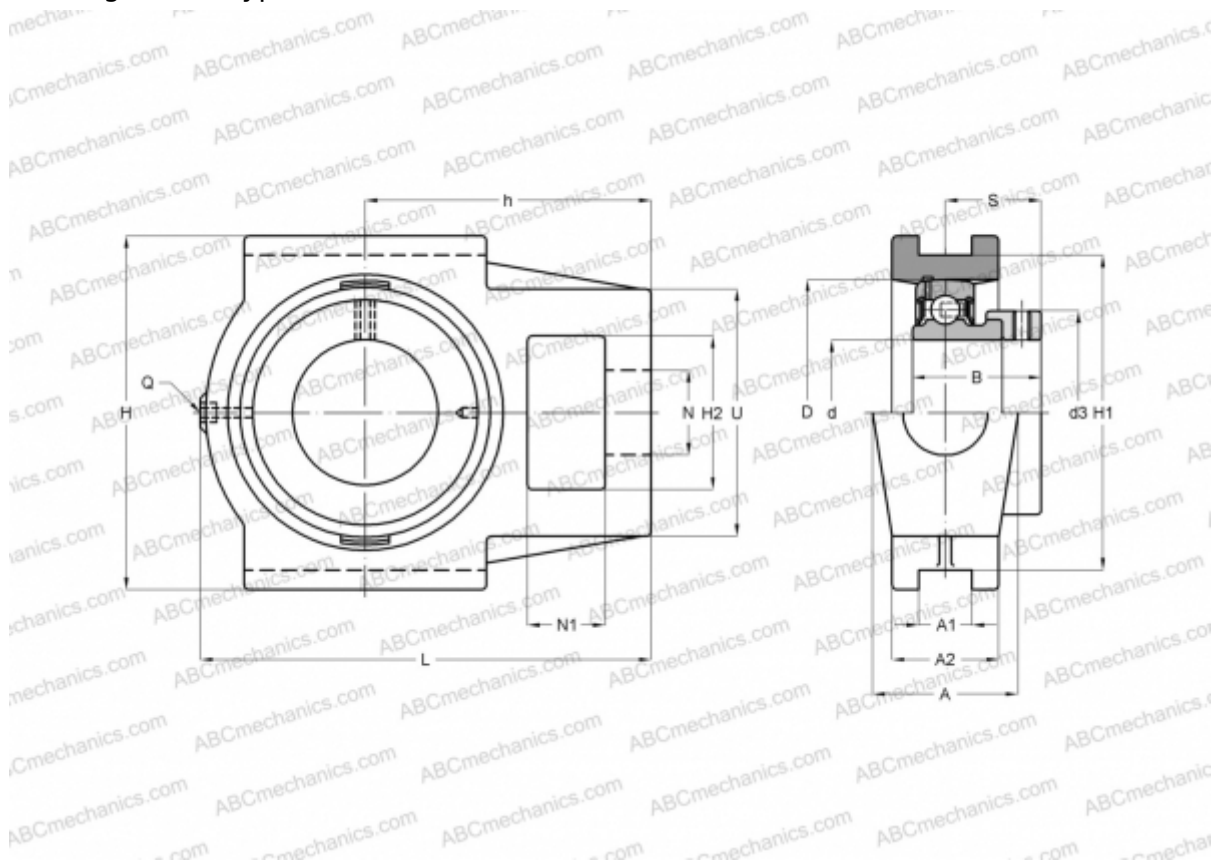

### Technical specification

#### DIMENSIONS, MM

d	20,000
D	47,000
B	31,000
L	97,000
H	92,000
A	34,000
H2	32,000
A1	13,500
A2	25,000
H1	76,000
N	19,000
N1	16,000
S	23,500
d3	32,400
U	54,000

#### DIMENSIONS, MM

h	62,000
---	--------

#### WEIGHT, KG

	0,730
Bearing	YET 204
Housing	TU 504 M
Protective cover	ECY 204

#### MANUFACTURER

[SKF](#)

#### CALCULATION DATA

Basic dynamic load rating, C	12,700 kN
Basic static load rating, Co	6,550 kN
Fatigue load limit, Pu	0,280 kN
Limiting speed	8500 r/min