

TU 35 FM SKF

Ball bearing units

TYPE: Housing units, Take-up housing units, Cast iron housing, Radial insert ball bearing with eccentric locking collar, Type TU..FM (SKF)

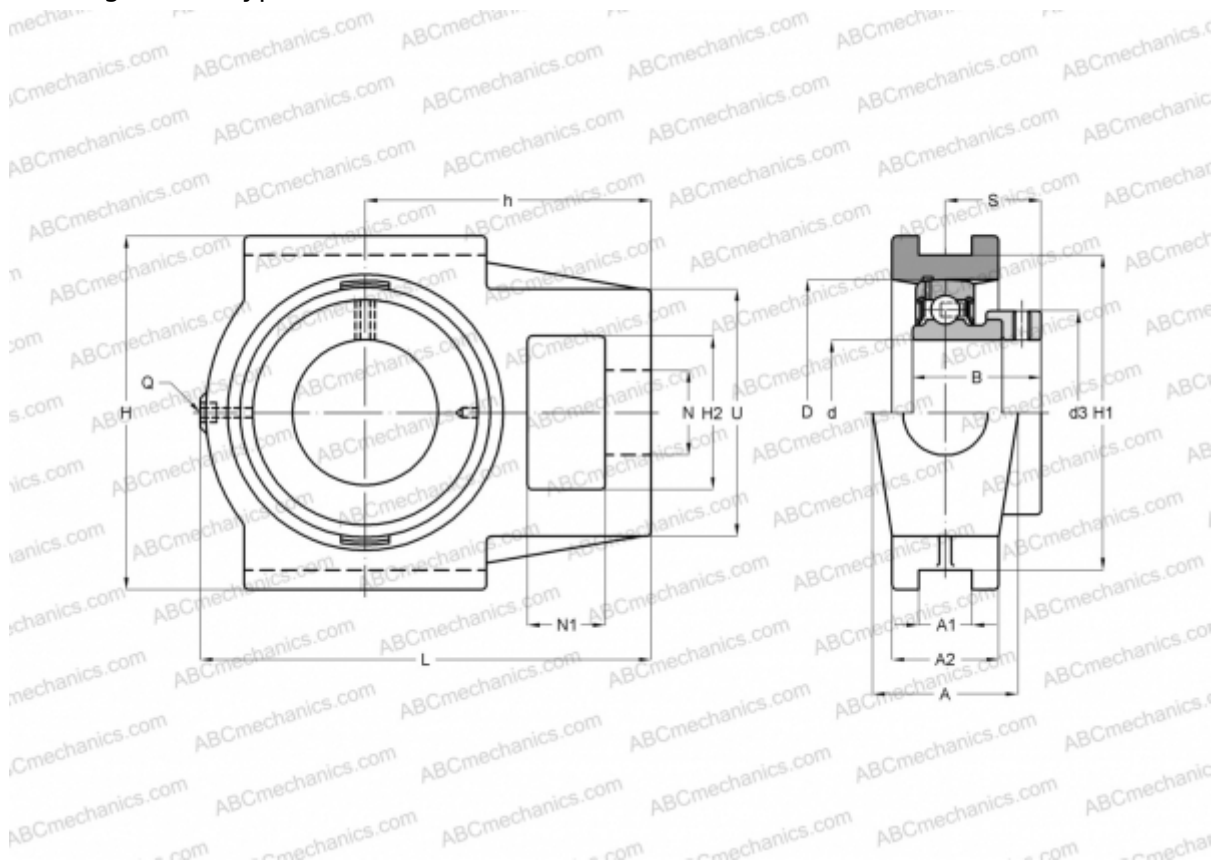

Technical specification

DIMENSIONS, MM

d	35,000
D	72,000
B	38,900
L	129,000
H	103,000
A	37,000
H2	38,000
A1	13,500
A2	30,000
H1	89,000
N	22,000
N1	17,000
S	29,400
d3	51,100
U	64,000

DIMENSIONS, MM

h	78,000
---	--------

WEIGHT, KG

Weight	1,450
Bearing	YET 207
Housing	TU 507 M
Protective cover	ECY 207

MANUFACTURER

[SKF](#)

CALCULATION DATA

Basic dynamic load rating, C	25,500 kN
Basic static load rating, Co	15,300 kN
Fatigue load limit, Pu	0,655 kN
Limiting speed	5300 r/min