

## TU 40 FM SKF

Ball bearing units

TYPE: Housing units, Take-up housing units, Cast iron housing, Radial insert ball bearing with eccentric locking collar, Type TU..FM (SKF)

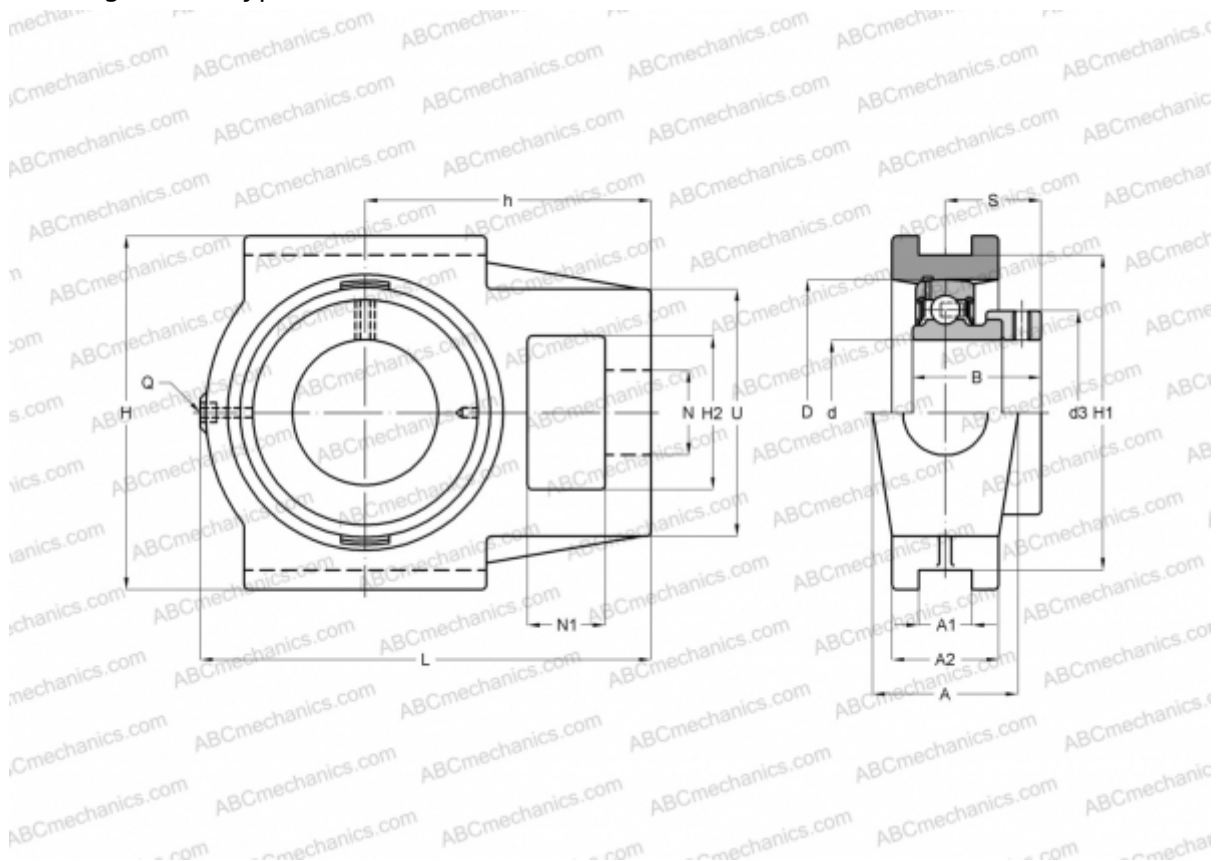

### Technical specification

#### DIMENSIONS, MM

d	40,000
D	80,000
B	43,700
L	145,000
H	115,000
A	49,000
H2	50,000
A1	17,500
A2	33,000
H1	101,000
N	29,000
N1	19,000
S	32,700
d3	56,500
U	83,000

#### DIMENSIONS, MM

h	88,000
---	--------

#### WEIGHT, KG

Weight	2,300
Bearing	YET 208
Housing	TU 508 M
Protective cover	ECY 208

#### MANUFACTURER

[SKF](#)

#### CALCULATION DATA

Basic dynamic load rating, C	30,700 kN
Basic static load rating, Co	19,000 kN
Fatigue load limit, Pu	0,800 kN
Limiting speed	4800 r/min