

SY 50 TF/VA228 SKF

Ball bearing units

TYPE: Housing units, Plummer block, Cast iron housing, Radial insert ball bearing with grub screws in inner ring, Type SY..TF/VA228, high temperature, for high demands (-150°/+350°) (SKF)

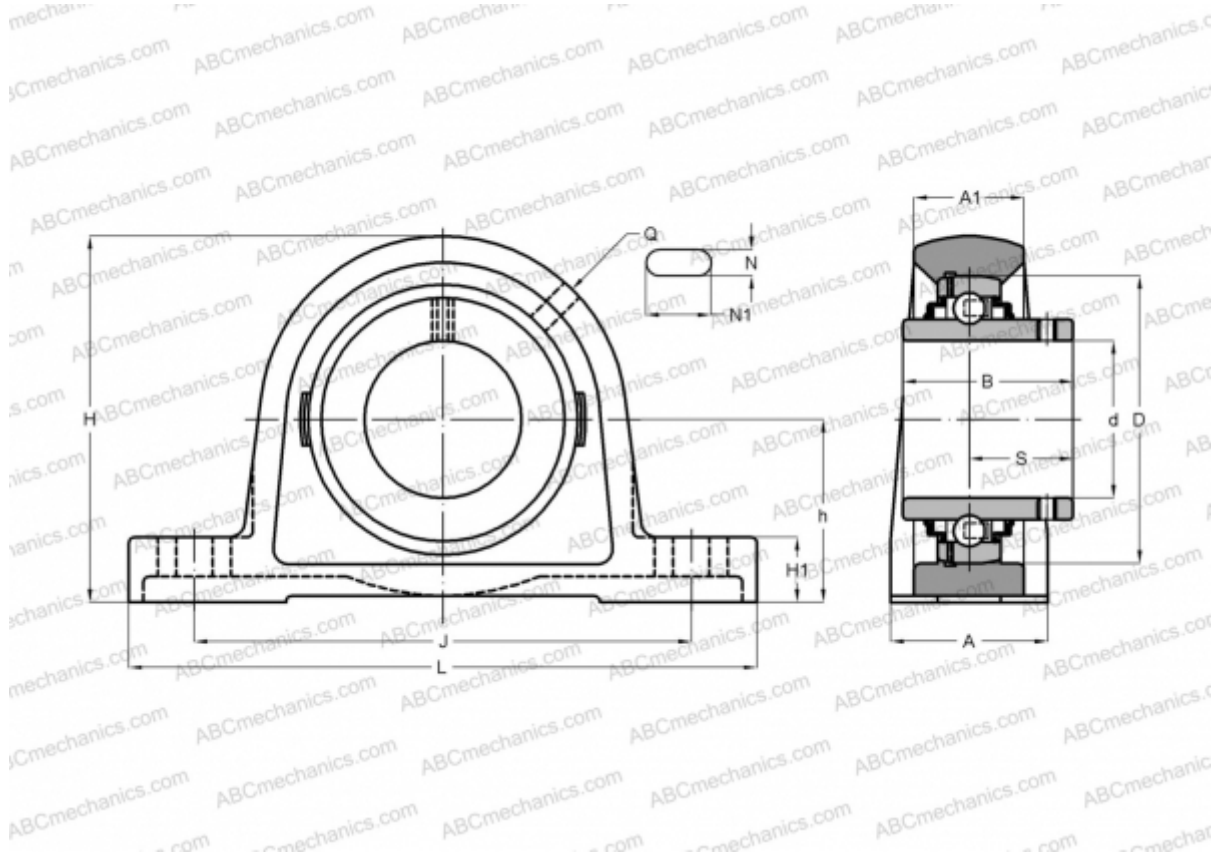

Technical specification

DIMENSIONS, MM

d	50,000
D	90,000
B	51,600
L	203,000
H	114,000
A	54,000
J	157,000
H1	22,000
N	18,000
N1	26,000
h	57,200

WEIGHT, KG

2,700

Bearing

YAR 210-
2F/VA228

Housing

SY 510

MANUFACTURER

U/VA228
[SKF](#)

CALCULATION DATA

Basic dynamic load rating, C	35,100 kN
Basic static load rating, Co	23,200 kN
Limiting speed	120 r/min
Operating temperature max	350 °C