

## SY 1.1/2 TF/VA201 SKF

Ball bearing units

TYPE: Housing units, Plummer block, Cast iron housing, Radial insert ball bearing with grub screws in inner ring, Type SY..TF/VA201, high temperature, inch (-40°/+250°) (SKF)

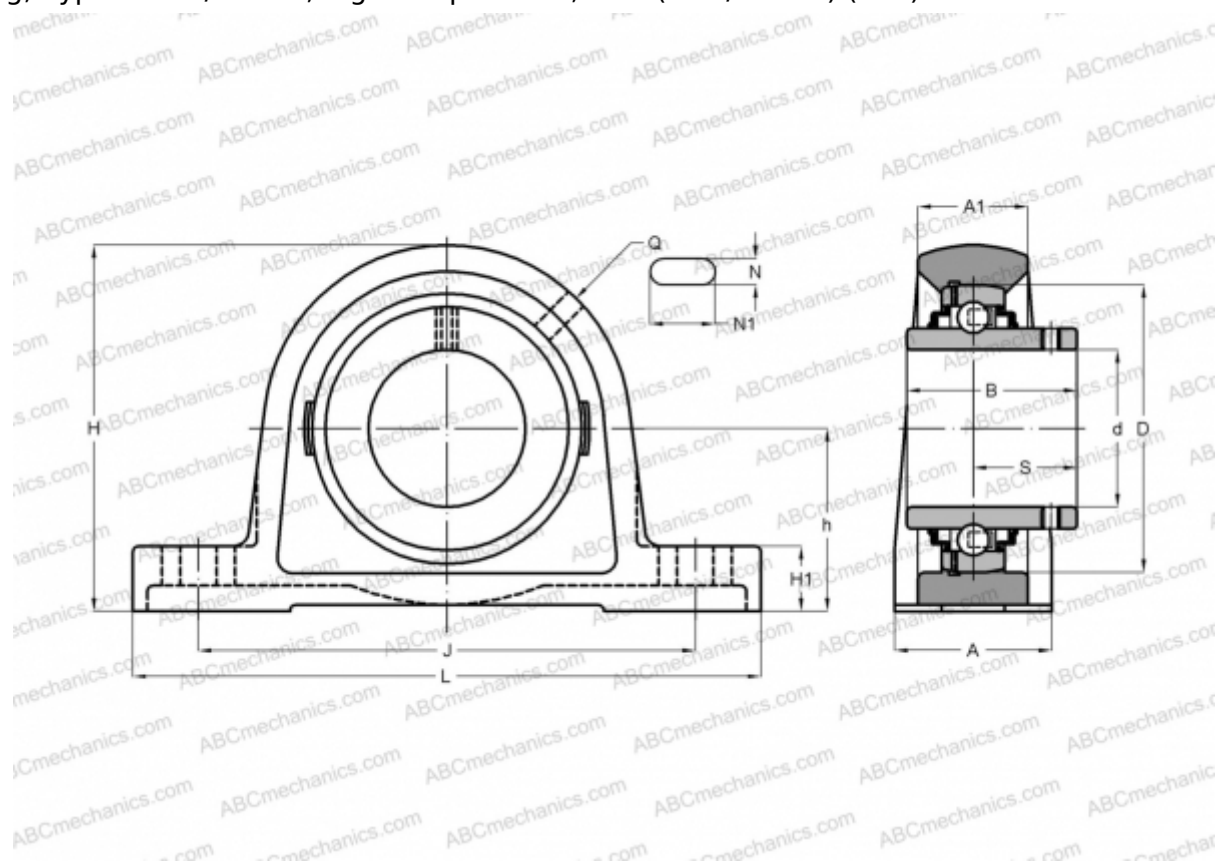

### Technical specification

#### DIMENSIONS, MM

d	38,100
D	80,000
B	49,200
L	175,000
H	99,000
A	48,000
J	135,500
H1	19,000
N	14,000
N1	24,500
h	49,200

#### WEIGHT, KG

1,800

Bearing

YAR 208-108  
2F/VA201

Housing

SY 508

#### MANUFACTURER

U/VA228  
[SKF](#)

#### CALCULATION DATA

Basic dynamic load rating, C	30,700 kN
Basic static load rating, Co	19,000 kN
Limiting speed	70 r/min
Operating temperature max	250 °C