

FY 20 TF/VA201 SKF

Ball bearing units

TYPE: Housing units, Four-bolt flanged housing units, Cast iron housing, Radial insert ball bearing with grub screws in inner ring, Type FY..TF/VA201, high temperature (-40°/+250°) (SKF)

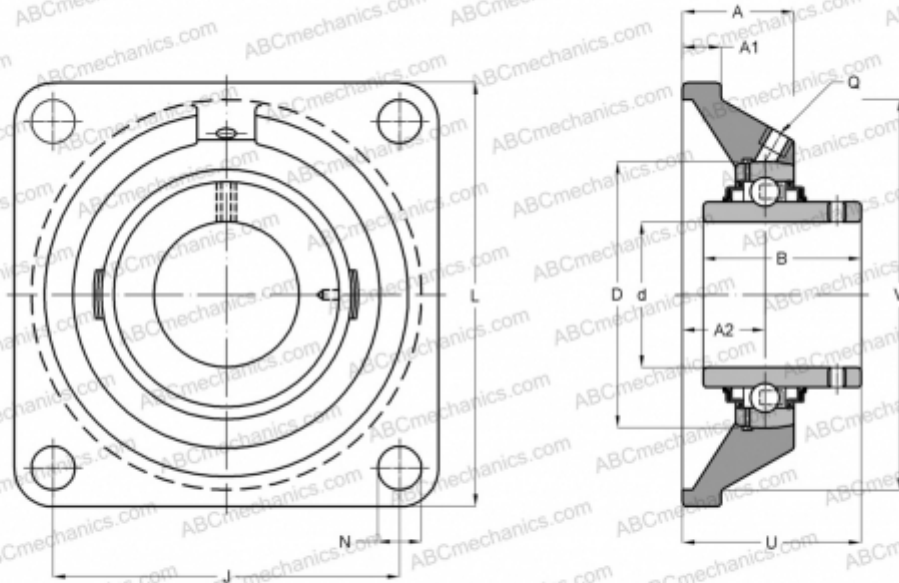

Technical specification

DIMENSIONS, MM

d	20,000
D	47,000
B	31,000
L	86,000
A	29,500
J	63,500
A1	11,000
N	11,100
U	37,300

WEIGHT, KG

0,600

Bearing	YAR 204-
Housing	FY 504
	U/VA228

MANUFACTURER

[SKF](#)

CALCULATION DATA

Basic dynamic load rating, C	12,700 kN
Basic static load rating, Co	6,550 kN
Limiting speed	130 r/min
Operating temperature max	250 °C