

## FY 35 TF/VA201 SKF

Ball bearing units

TYPE: Housing units, Four-bolt flanged housing units, Cast iron housing, Radial insert ball bearing with grub screws in inner ring, Type FY..TF/VA201, high temperature (-40°/+250°) (SKF)

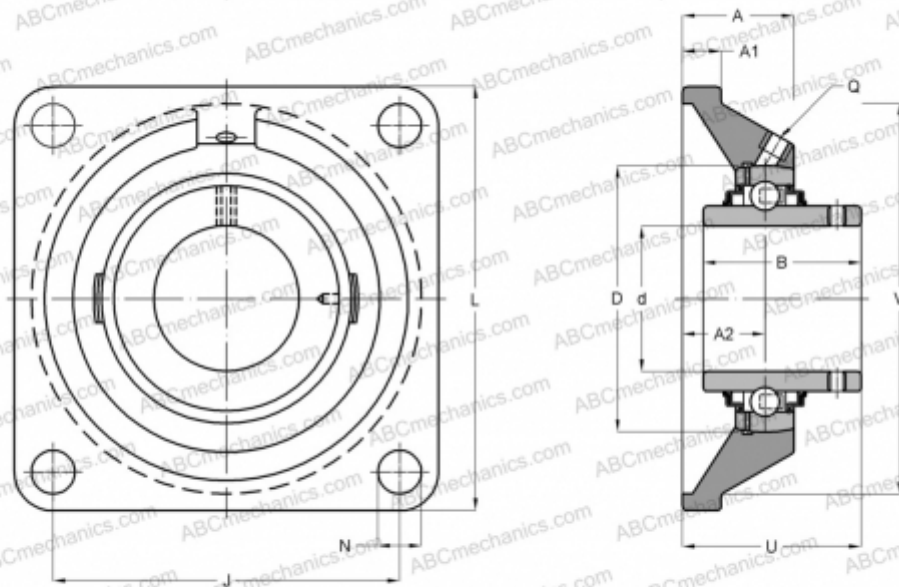

### Technical specification

#### DIMENSIONS, MM

d	35,000
D	72,000
B	42,900
L	118,000
A	34,500
J	92,000
A1	13,000
N	14,300
U	46,400

#### WEIGHT, KG

1,400

Bearing	YAR 207-
Housing	FY 507 U/VA228

#### MANUFACTURER

[SKF](#)

#### CALCULATION DATA

Basic dynamic load rating, C	25,500 kN
Basic static load rating, Co	15,300 kN
Limiting speed	80 r/min
Operating temperature max	250 °C