

FY 45 TF/VA201 SKF

Ball bearing units

TYPE: Housing units, Four-bolt flanged housing units, Cast iron housing, Radial insert ball bearing with grub screws in inner ring, Type FY..TF/VA201, high temperature (-40°/+250°) (SKF)

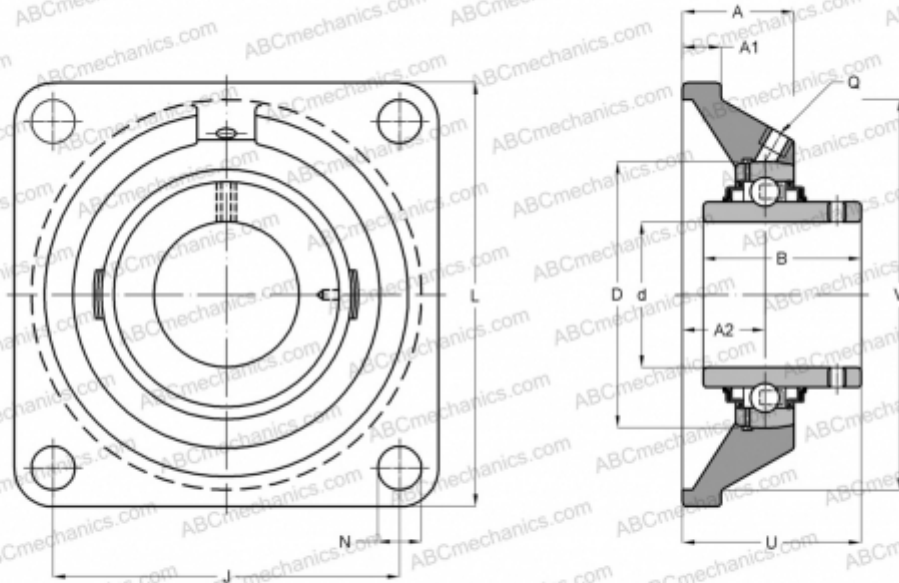

Technical specification

DIMENSIONS, MM

d	45,000
D	85,000
B	49,200
L	137,000
A	39,000
J	105,000
A1	14,000
N	15,900
U	54,200

WEIGHT, KG

2,100

Bearing	YAR 209-
Housing	FY 509 U/VA228

MANUFACTURER

[SKF](#)

CALCULATION DATA

Basic dynamic load rating, C	33,200 kN
Basic static load rating, Co	21,600 kN
Limiting speed	60 r/min
Operating temperature max	250 °C