

## FY 20 TF/VA228 SKF

Ball bearing units

TYPE: Housing units, Four-bolt flanged housing units, Cast iron housing, Radial insert ball bearing with grub screws in inner ring, Type FY..TF/VA228, high temperature, for high demands (-150°/+350°) (SKF)

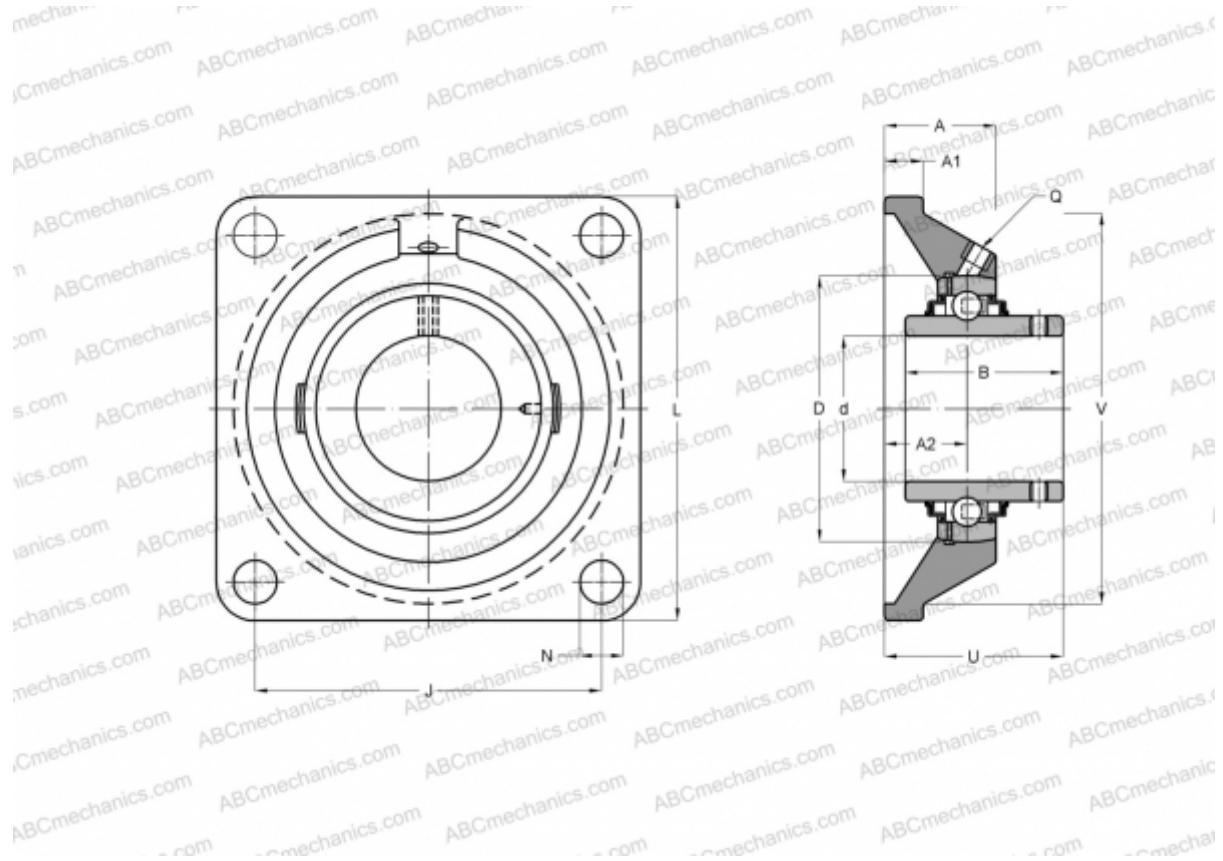

### Technical specification

#### DIMENSIONS, MM

d	20,000
D	47,000
B	31,000
L	86,000
A	29,500
J	63,500
A1	11,000
N	11,100
U	37,300

**WEIGHT, KG** 0,600

Bearing YAR 204-  
Housing FY 504  
U/VA228

#### MANUFACTURER

[SKF](#)

#### CALCULATION DATA

Basic dynamic load rating, C	12,700 kN
Basic static load rating, Co	6,550 kN
Limiting speed	260 r/min
Operating temperature max	350 °C