

FY 1. TF/VA228 SKF

Ball bearing units

TYPE: Housing units, Four-bolt flanged housing units, Cast iron housing, Radial insert ball bearing with grub screws in inner ring, Type FY..TF/VA228, high temperature, for high demands, inch size (-150°/+350°) (SKF)

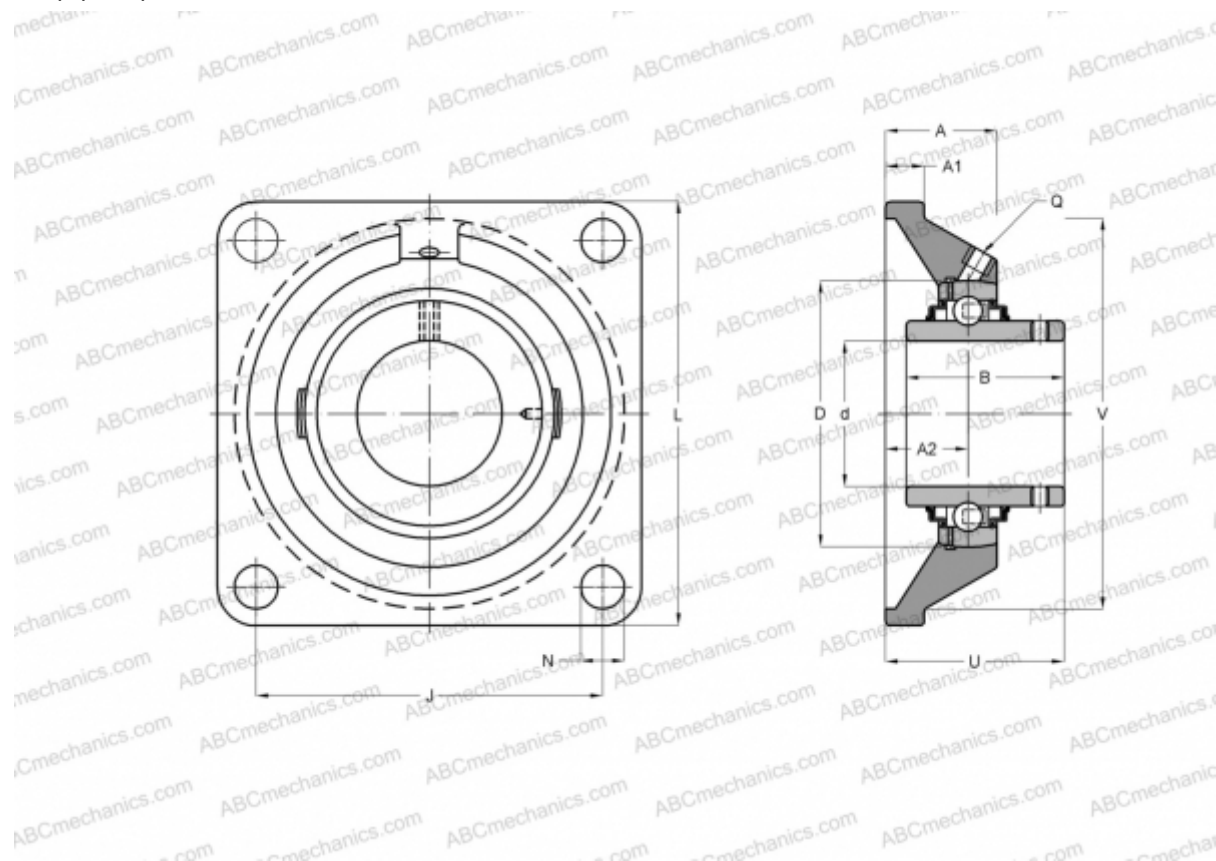

Technical specification

DIMENSIONS, MM

d	25,400
D	52,000
B	34,100
L	95,000
A	30,000
J	70,000
A1	12,000
N	12,700
U	38,800

WEIGHT, KG 0,770

Bearing	YAR 205-100-
Housing	FY 505
	U/VA228

MANUFACTURER

[SKF](#)

CALCULATION DATA

Basic dynamic load rating, C	14,000 kN
Basic static load rating, Co	7,800 kN
Limiting speed	230 r/min
Operating temperature max	350 °C