

FY 1.3/16 TF/VA228 SKF

Ball bearing units

TYPE: Housing units, Four-bolt flanged housing units, Cast iron housing, Radial insert ball bearing with grub screws in inner ring, Type FY..TF/VA228, high temperature, for high demands, inch size (-150°/+350°) (SKF)

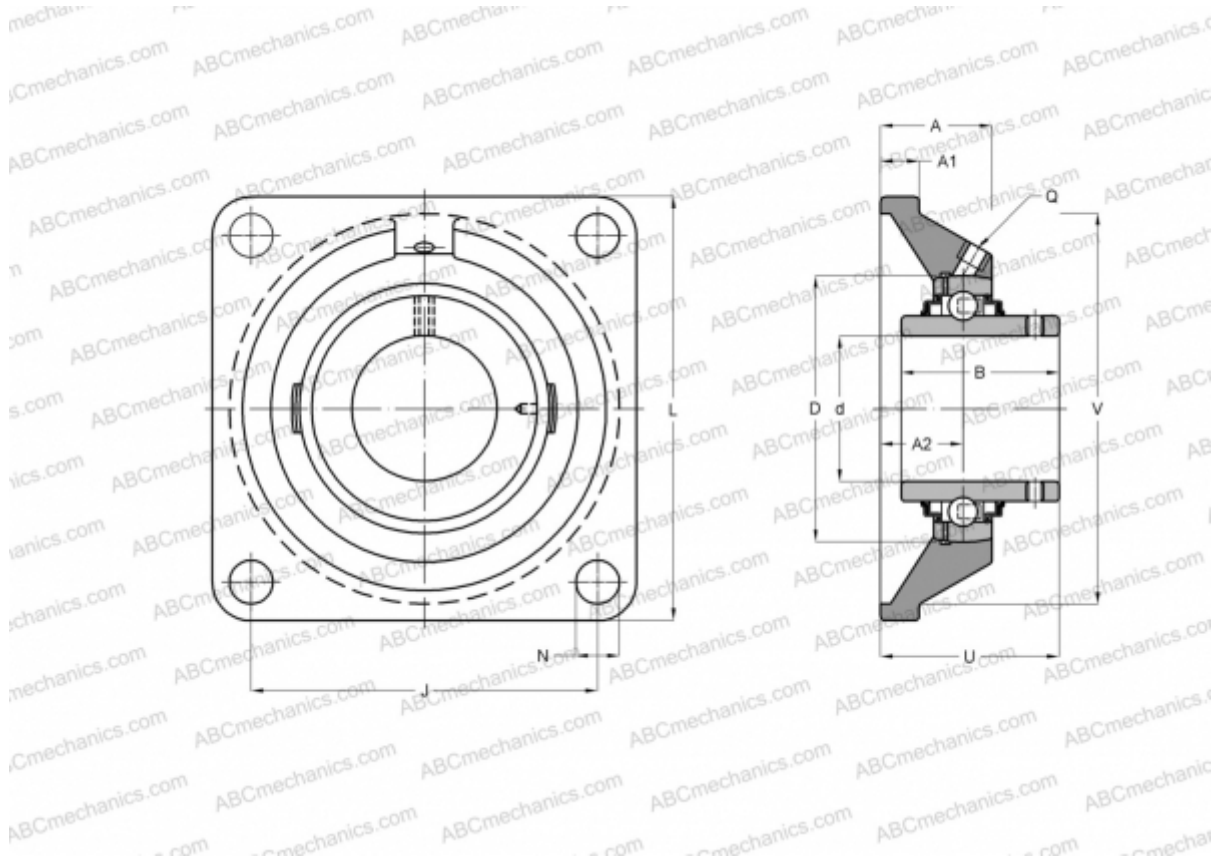

Technical specification

DIMENSIONS, MM

d	30,162
D	62,000
B	38,100
L	108,000
A	32,500
J	82,500
A1	13,000
N	12,700
U	42,200

WEIGHT, KG 1,100

Bearing YAR 206-103-
Housing FY 506
U/VA228

MANUFACTURER

[SKF](#)

CALCULATION DATA

Basic dynamic load rating, C	19,500 kN
Basic static load rating, Co	11,200 kN
Limiting speed	190 r/min
Operating temperature max	350 °C