

FY 1.3/4 TF/VA228 SKF

Ball bearing units

TYPE: Housing units, Four-bolt flanged housing units, Cast iron housing, Radial insert ball bearing with grub screws in inner ring, Type FY..TF/VA228, high temperature, for high demands, inch size (-150°/+350°) (SKF)

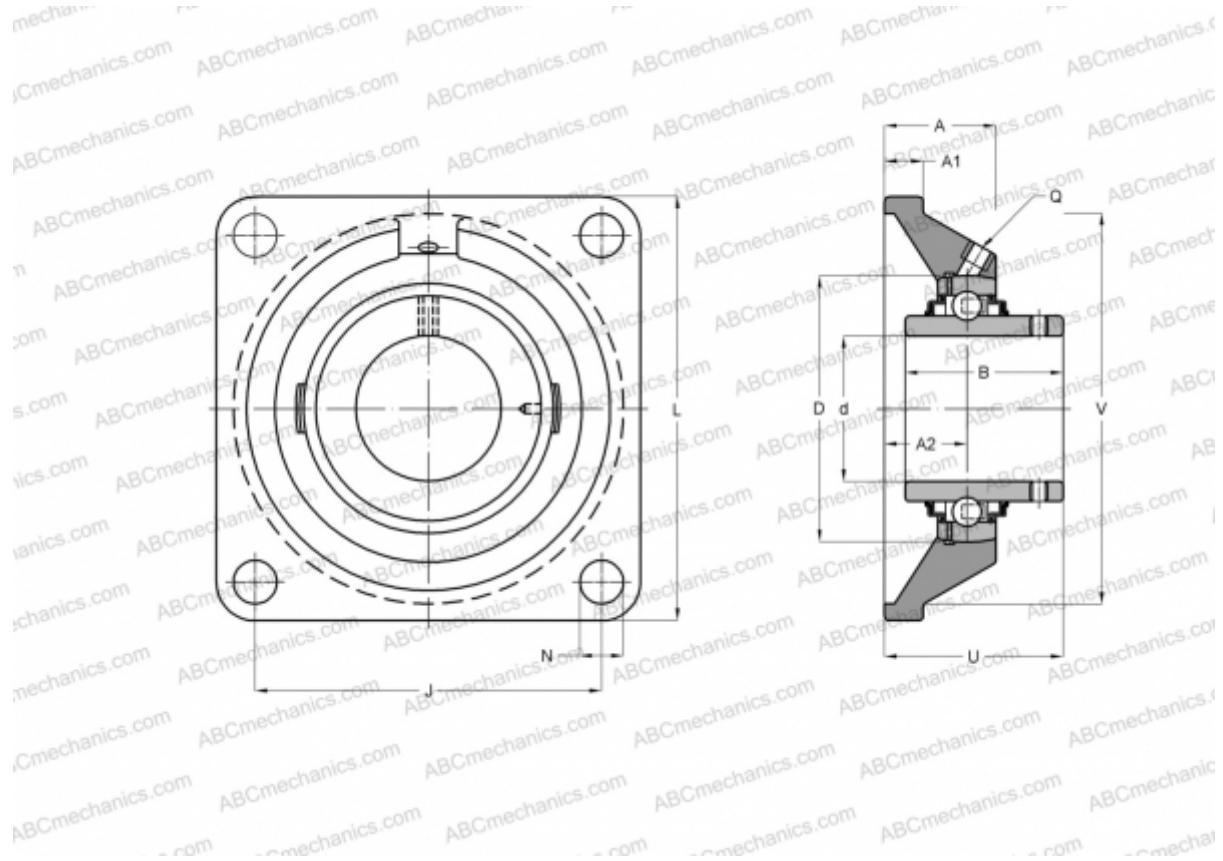

Technical specification

DIMENSIONS, MM

d	44,450
D	85,000
B	49,200
L	137,000
A	39,000
J	105,000
A1	14,000
N	15,900
U	54,200

WEIGHT, KG 2,100

Bearing YAR 209-112-
Housing FY 509
U/VA228

MANUFACTURER

[SKF](#)

CALCULATION DATA

Basic dynamic load rating, C	33,200 kN
Basic static load rating, Co	21,600 kN
Limiting speed	130 r/min
Operating temperature max	350 °C