

FY 2.3/16 TF/VA228 SKF

Ball bearing units

TYPE: Housing units, Four-bolt flanged housing units, Cast iron housing, Radial insert ball bearing with grub screws in inner ring, Type FY..TF/VA228, high temperature, for high demands, inch size (-150°/+350°) (SKF)

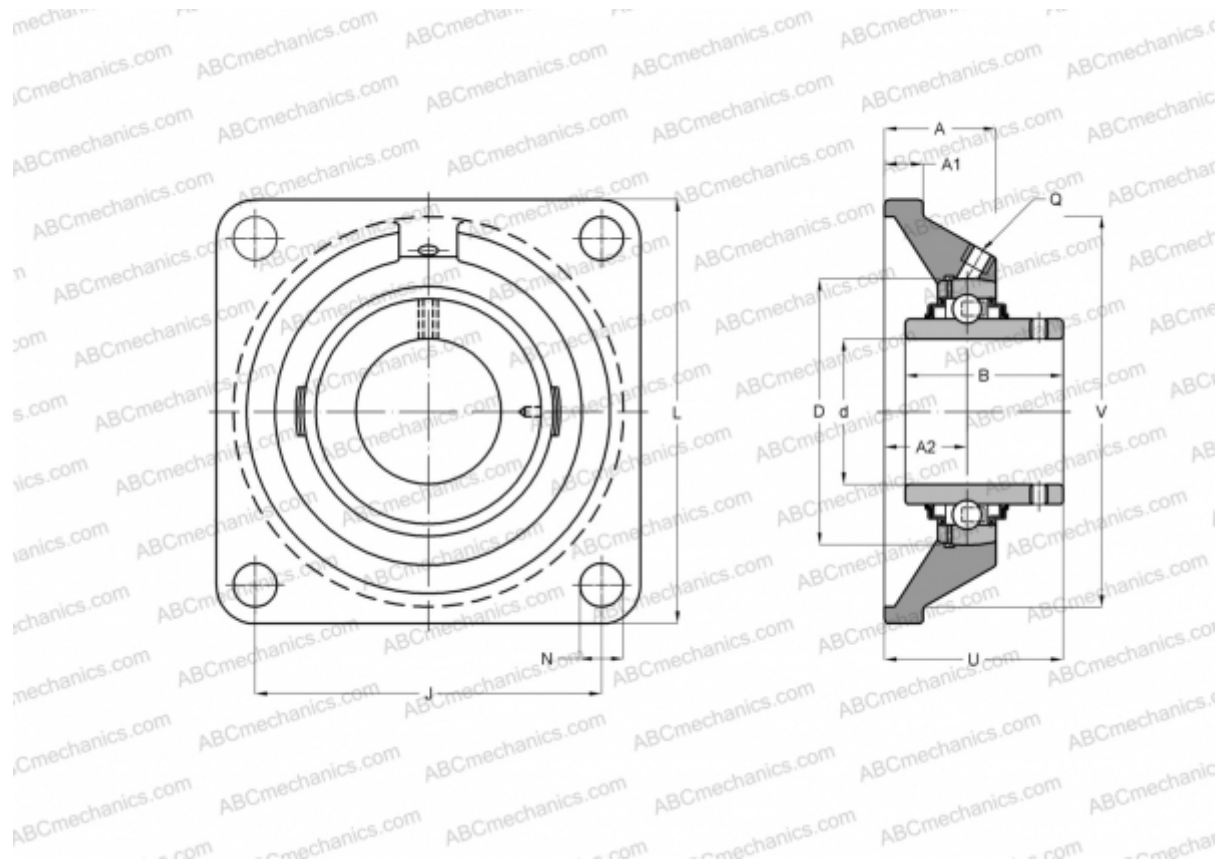

Technical specification

DIMENSIONS, MM

d	55,562
D	100,000
B	55,600
L	162,000
A	47,500
J	130,000
A1	16,000
N	19,000
U	64,400

WEIGHT, KG 3,700

Bearing	YAR 211-203
Housing	FY 511
	U/VA228

MANUFACTURER

[SKF](#)

CALCULATION DATA

Basic dynamic load rating, C	43,600 kN
Basic static load rating, Co	29,000 kN
Limiting speed	110 r/min
Operating temperature max	350 °C