

FYT 35 TF/VA201 SKF

Ball bearing units

TYPE: Housing units, Two-bolt flanged housing units, Cast iron housing, Radial insert ball bearing with grub screws in inner ring, Type FYT..TF/VA201, high temperature (-40°/+250°) (SKF)

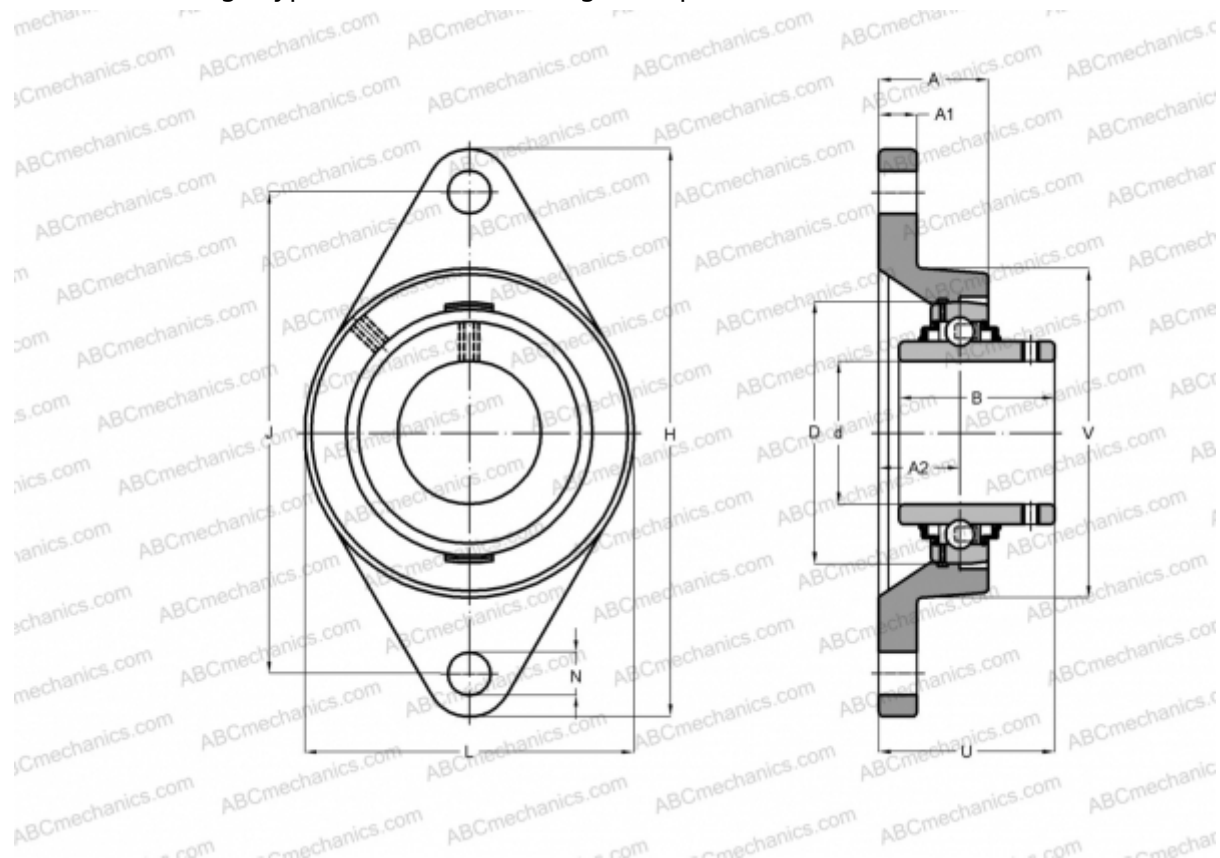

Technical specification

DIMENSIONS, MM

d	35,000
D	72,000
B	42,900
L	96,000
H	156,000
A	34,900
J	130,200
A1	13,000
A2	17,500
N	14,300
U	46,400

WEIGHT, KG

1,250

Bearing

YAR 207-
2F/VA201

Housing

FYT 507

MANUFACTURER

U/VA228
[SKF](#)

CALCULATION DATA

Basic dynamic load rating, C	25,500 kN
Basic static load rating, Co	15,300 kN
Limiting speed	80 r/min
Operating temperature max	250 °C