

FYT 40 TF/VA228 SKF

Ball bearing units

TYPE: Housing units, Two-bolt flanged housing units, Cast iron housing, Radial insert ball bearing with grub screws in inner ring, Type FYT..TF/VA228, high temperature, for high demands (-150°/+350°) (SKF)

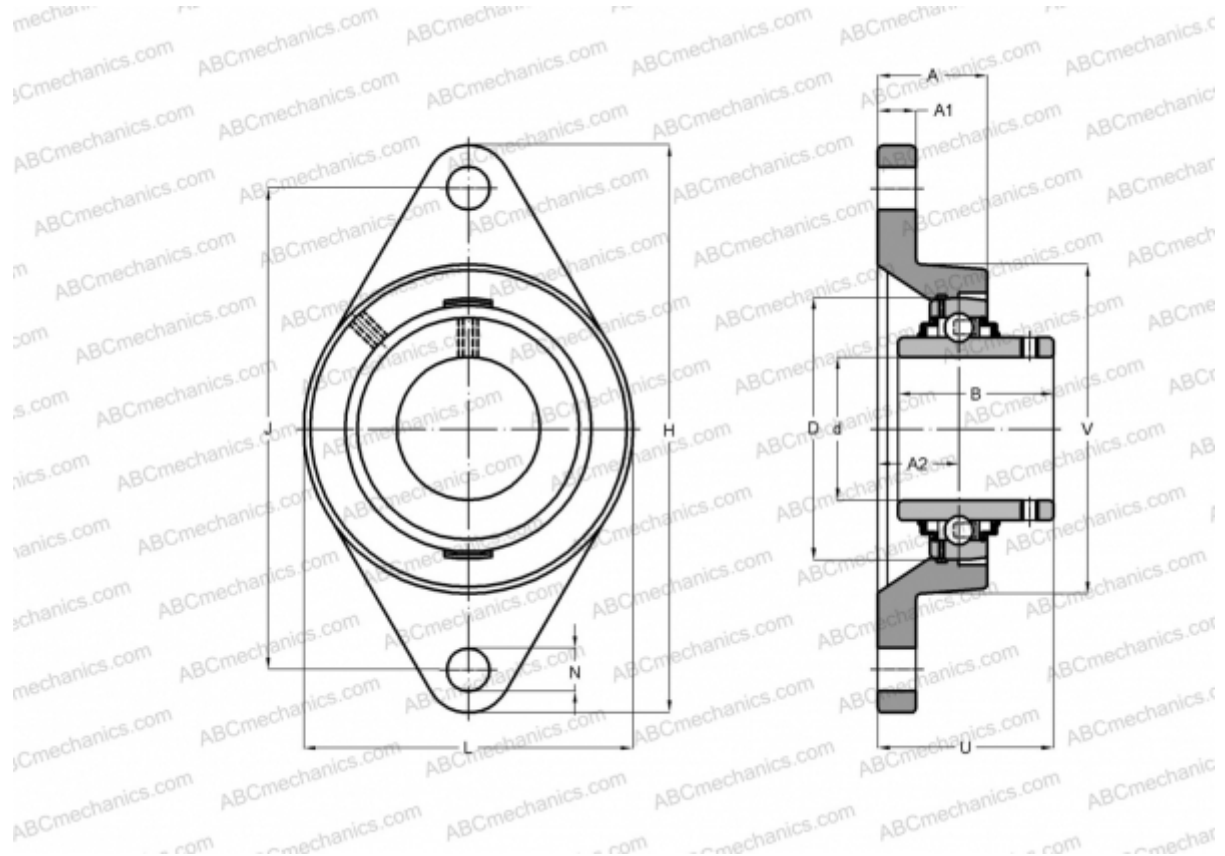

Technical specification

DIMENSIONS, MM

d	40,000
D	80,000
B	49,200
L	102,000
H	171,500
A	38,500
J	143,700
A1	14,000
A2	19,000
N	14,300
U	54,200

WEIGHT, KG

1,650

Bearing

YAR 208-
2F/VA228

Housing

FYT 508

MANUFACTURER

U/VA228
[SKF](#)

CALCULATION DATA

Basic dynamic load rating, C	30,700 kN
Basic static load rating, Co	19,000 kN
Limiting speed	150 r/min
Operating temperature max	350 °C