

FYT 45 TF/VA228 SKF

Ball bearing units

TYPE: Housing units, Two-bolt flanged housing units, Cast iron housing, Radial insert ball bearing with grub screws in inner ring, Type FYT..TF/VA228, high temperature, for high demands (-150°/+350°) (SKF)

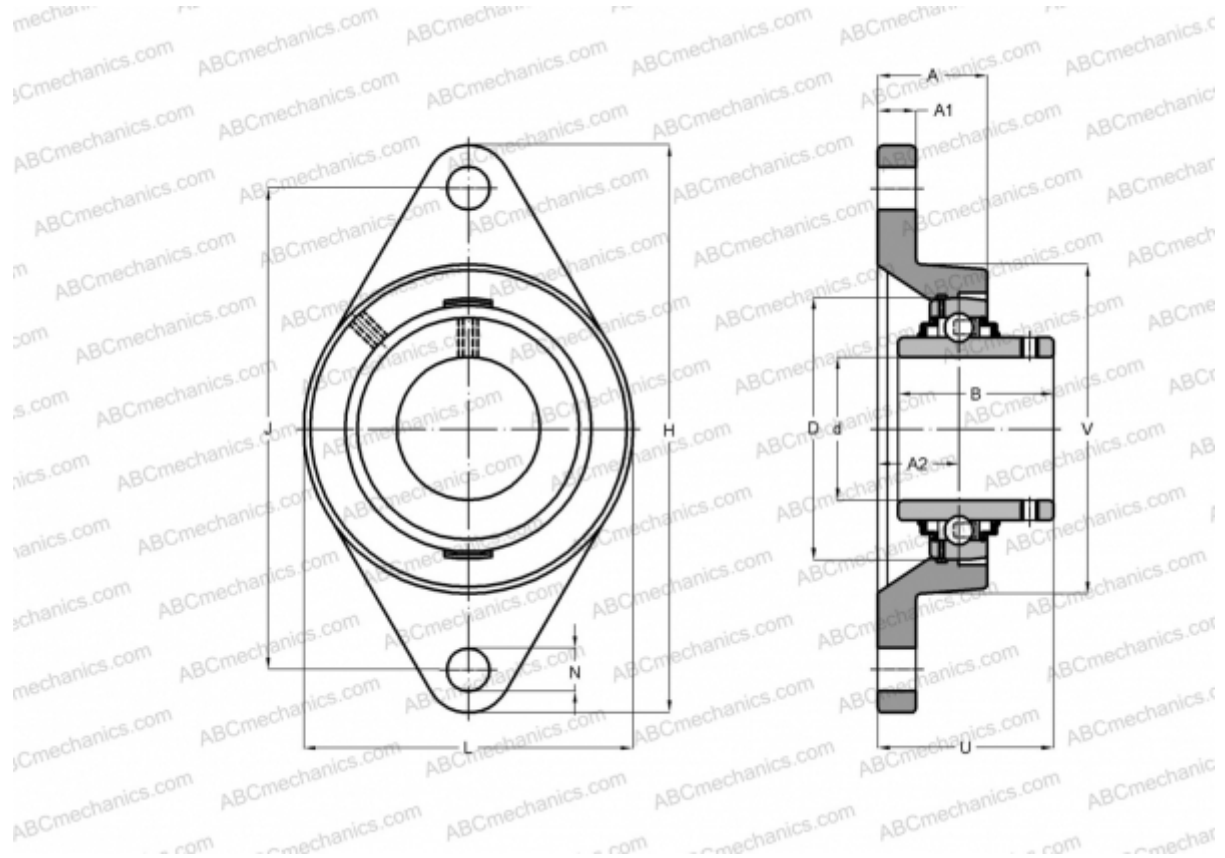

Technical specification

DIMENSIONS, MM

d	45,000
D	85,000
B	49,200
L	111,000
H	178,500
A	39,000
J	148,500
A1	14,000
A2	19,000
N	15,900
U	54,200

WEIGHT, KG 1,800

Bearing YAR 209-2F/VA228

Housing FYT 509

MANUFACTURER

U/VA228
[SKF](#)

CALCULATION DATA

Basic dynamic load rating, C	33,200 kN
Basic static load rating, Co	21,600 kN
Limiting speed	130 r/min
Operating temperature max	350 °C