

FYT 50 TF/VA228 SKF

Ball bearing units

TYPE: Housing units, Two-bolt flanged housing units, Cast iron housing, Radial insert ball bearing with grub screws in inner ring, Type FYT..TF/VA228, high temperature, for high demands (-150°/+350°) (SKF)

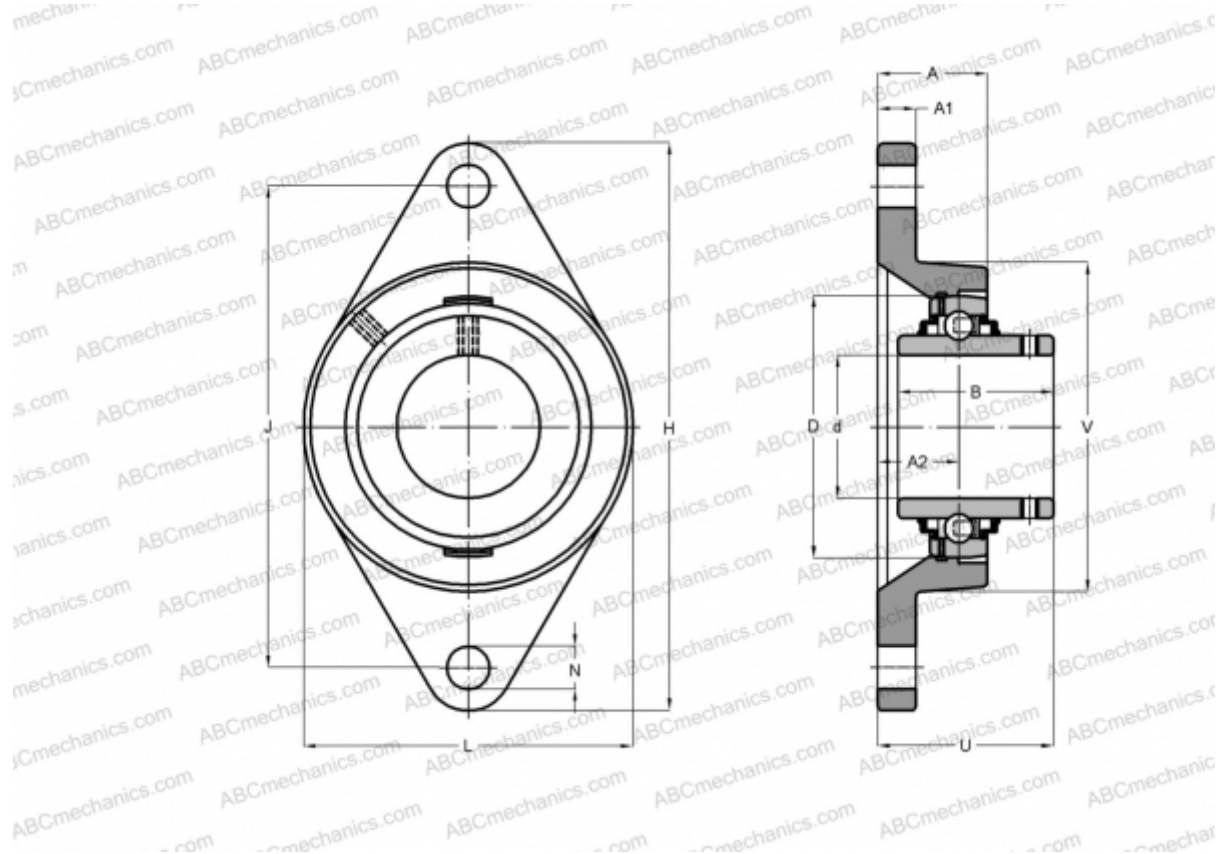

Technical specification

DIMENSIONS, MM

d	50,000
D	90,000
B	51,600
L	116,000
H	189,000
A	43,000
J	157,200
A1	15,000
A2	19,000
N	15,900
U	60,600

WEIGHT, KG 2,150

Bearing YAR 210-2F/VA228

Housing FYT 510

U/VA228
[SKF](#)

MANUFACTURER

CALCULATION DATA

Basic dynamic load rating, C	35,100 kN
Basic static load rating, Co	23,200 kN
Limiting speed	120 r/min
Operating temperature max	350 °C