

FYT 1.3/8 TF/VA201 SKF

Ball bearing units

TYPE: Housing units, Two-bolt flanged housing units, Cast iron housing, Radial insert ball bearing with grub screws in inner ring, Type FYT..TF/VA201, high temperature, inch size (-40°/+250°) (SKF)

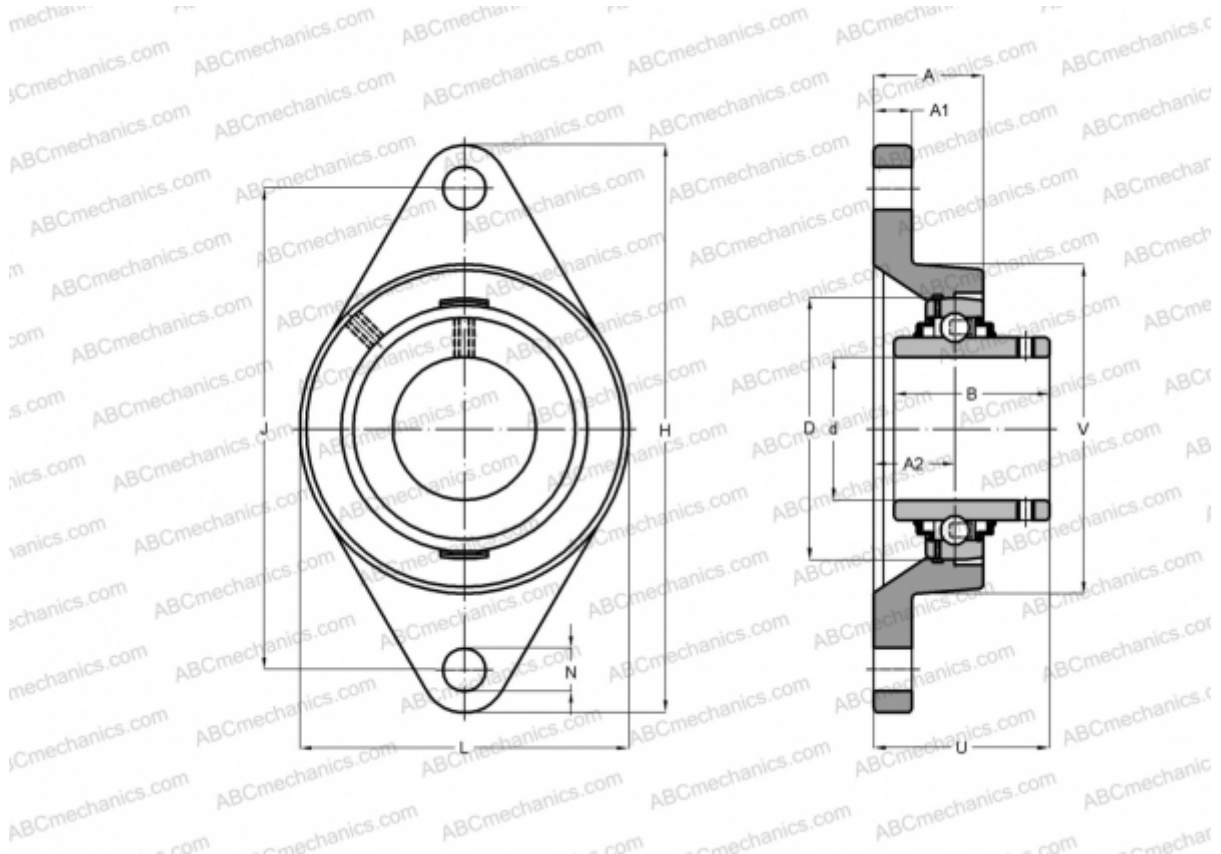

Technical specification

DIMENSIONS, MM

d	36,513
D	72,000
B	42,900
L	96,000
H	156,000
A	34,900
J	130,200
A1	13,000
A2	17,500
N	14,300
U	46,400

WEIGHT, KG 1,320

Bearing YAR 207-106-2F/VA201

Housing FYT 507

MANUFACTURER

U/VA228

[SKF](#)

CALCULATION DATA

Basic dynamic load rating, C	25,500 kN
Basic static load rating, Co	15,300 kN
Limiting speed	80 r/min
Operating temperature max	250 °C