

UDFL 204 ASAHI

Ball bearing units

TYPE: Housing units, Two-bolt flanged housing units, Cast iron housing, Radial insert ball bearing with eccentric locking collar, Type UDFL (ASAHI)

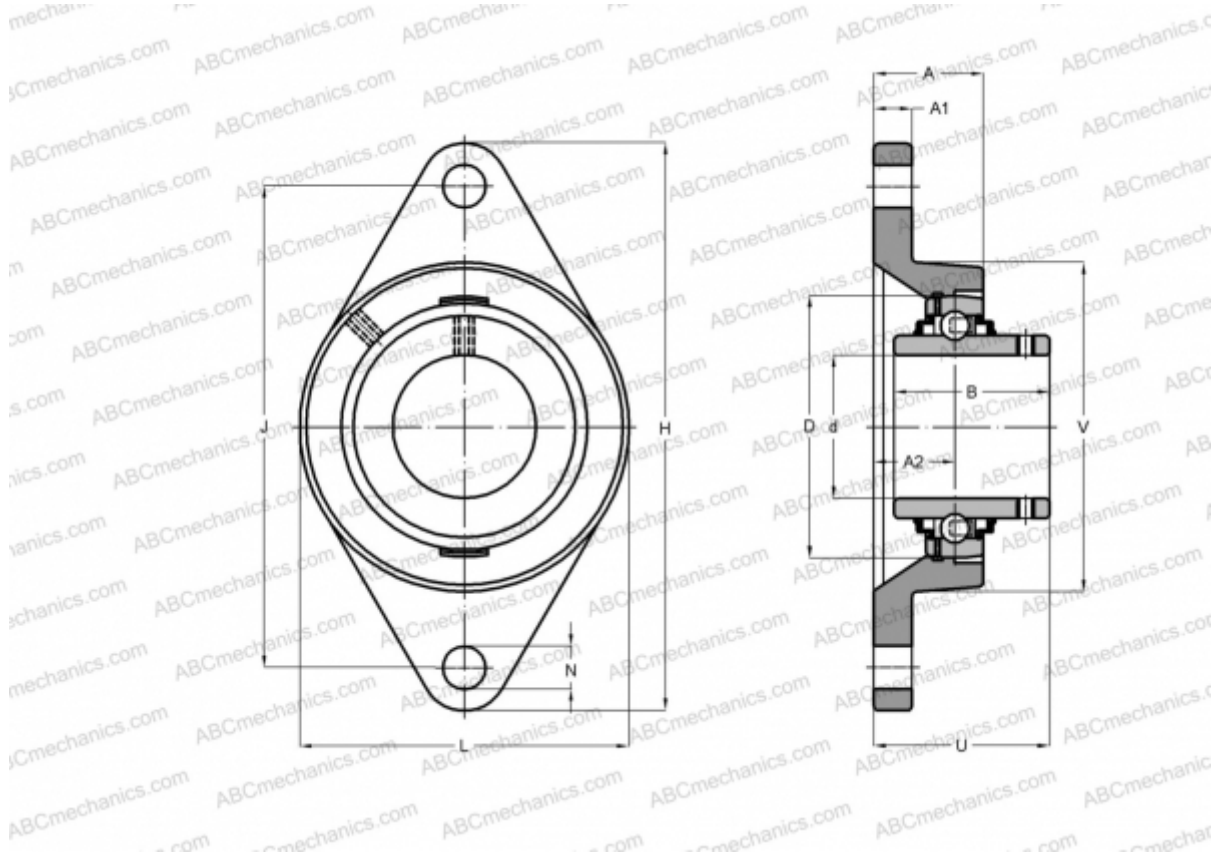

Technical specification

DIMENSIONS, MM

d	20,000
D	47,000
B	31,000
L	60,000
H	113,000
A	25,500
J	90,000
A1	12,000
A2	15,000
N	12,000
U	34,500

WEIGHT, KG

0,450

Bearing

UD 204 + EE

Housing

FL 204

MANUFACTURER

[ASAHI](#)