

UDFL 206 ASAHI

Ball bearing units

TYPE: Housing units, Two-bolt flanged housing units, Cast iron housing, Radial insert ball bearing with eccentric locking collar, Type UDFL (ASAHI)

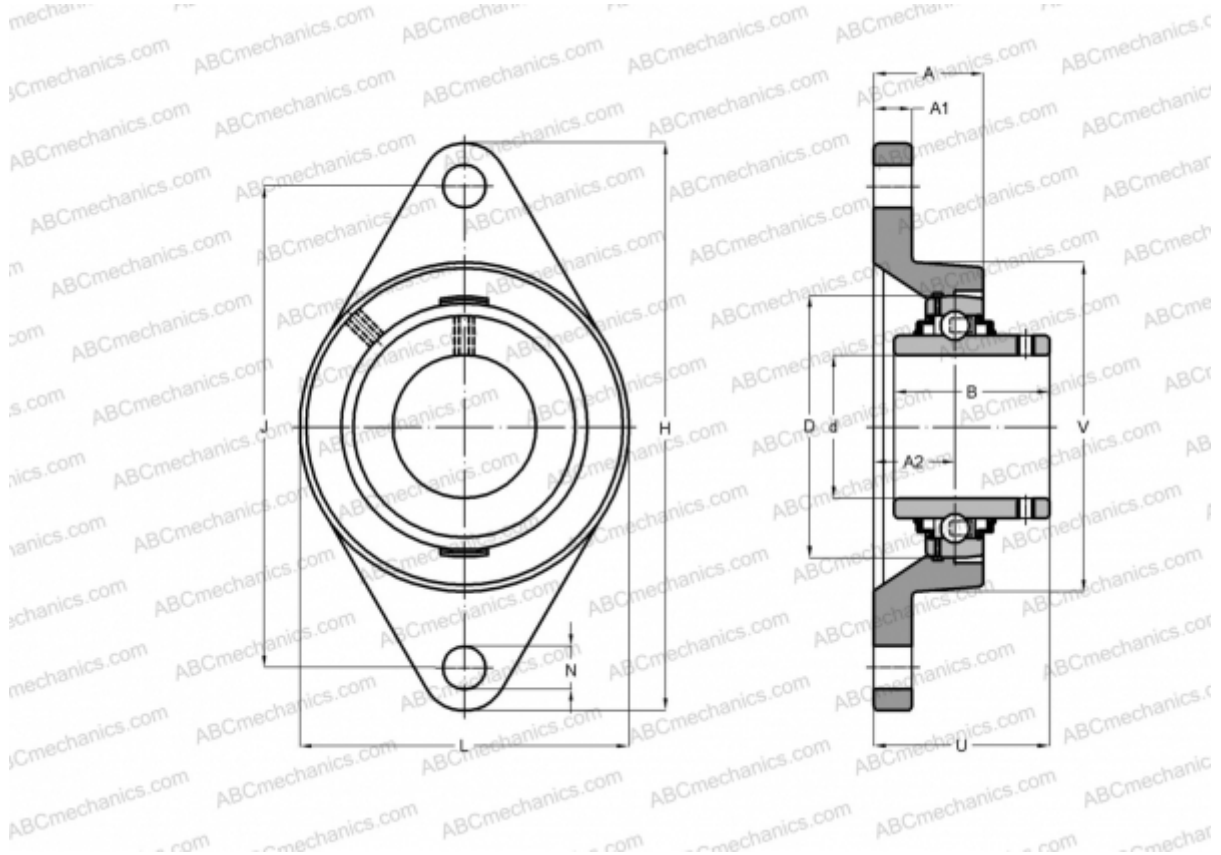

Technical specification

DIMENSIONS, MM

d	30,000
D	62,000
B	36,000
L	80,000
H	148,000
A	31,000
J	117,000
A1	14,000
A2	18,000
N	16,000
U	41,000

WEIGHT, KG 0,950

Bearing UD 206 + EE

Housing

FL 206

MANUFACTURER

[ASAHI](#)