

UDFL 210 ASAHI

Ball bearing units

TYPE: Housing units, Two-bolt flanged housing units, Cast iron housing, Radial insert ball bearing with eccentric locking collar, Type UDFL (ASAHI)

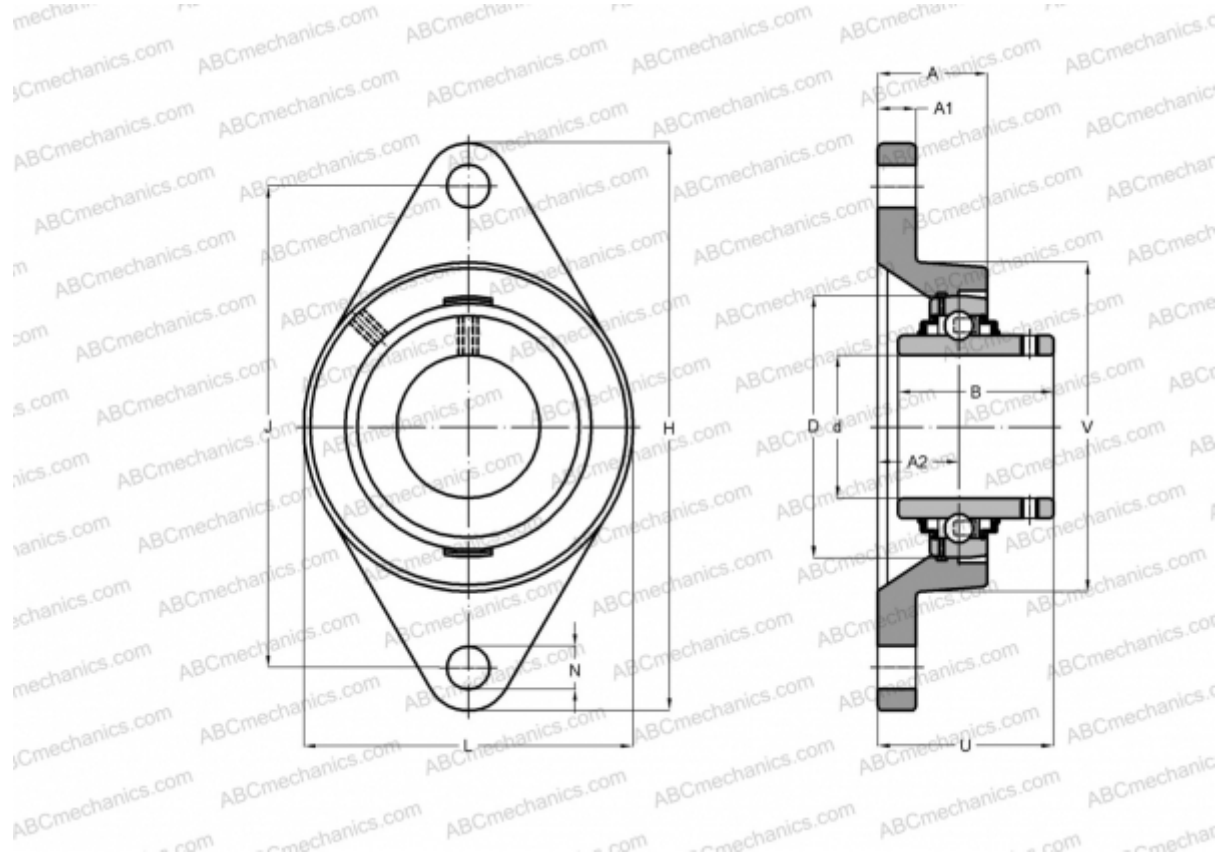

Technical specification

DIMENSIONS, MM

d	50,000
D	90,000
B	43,000
L	115,000
H	197,000
A	40,000
J	157,000
A1	18,000
A2	22,000
N	19,000
U	49,500

WEIGHT, KG

2,100

Bearing

UD 210 + EE

Housing

FL 210

MANUFACTURER

[ASAHI](#)